

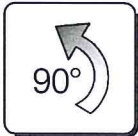





WICSTYLE 77FP

Konstruktionsschnitt Construction section

Symbole Symbols

Symbol	Bezeichnung	Symbol	Bezeichnung
Symbols	Designation	Symbols	Designation
	Rauchdicht bei Umgebungstemperatur nach DIN EN 1634-3 <i>Smoke control at ambient temperature according to DIN EN 1634-3</i>		Darstellung 90° gedreht <i>Representation turned by 90°</i>
	Rauchdicht bei 200° C nach DIN EN 1634-3 <i>Smoke control according to DIN EN 1634-3</i>		
	WICSTYLE FP EI ₂ 30 Brandschutztür oder EI 30 Brandschutzverglasung nach EN 1634-1 <i>WICSTYLE FP EI₂ 30 fire protection door or EI 30 fire protection fixed glazing according to EN 1634-1</i>		
	Selbstschließende Zyklen > 200.000 nach DIN EN 1191 <i>Self closing cycles > 200.000 according to DIN EN 1191</i>		
	Einbruchhemmung RC 1 N nach DIN EN 1627 <i>Burglary resistance class RC 1 N according to DIN EN 1627</i>		
	Einbruchhemmung RC 2 N nach DIN EN 1627 <i>Burglary resistance class RC 2 N according to DIN EN 1627</i>		
	Einbruchhemmung RC 2 nach DIN EN 1627 <i>Burglary resistance class RC 2 according to DIN EN 1627</i>		

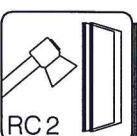
WICSTYLE 77FP

Anschlagtüren einwärts mit Spezialblendrahmen
 Hinged doors inwards with special frame

Konstruktionsschnitt
 Construction section

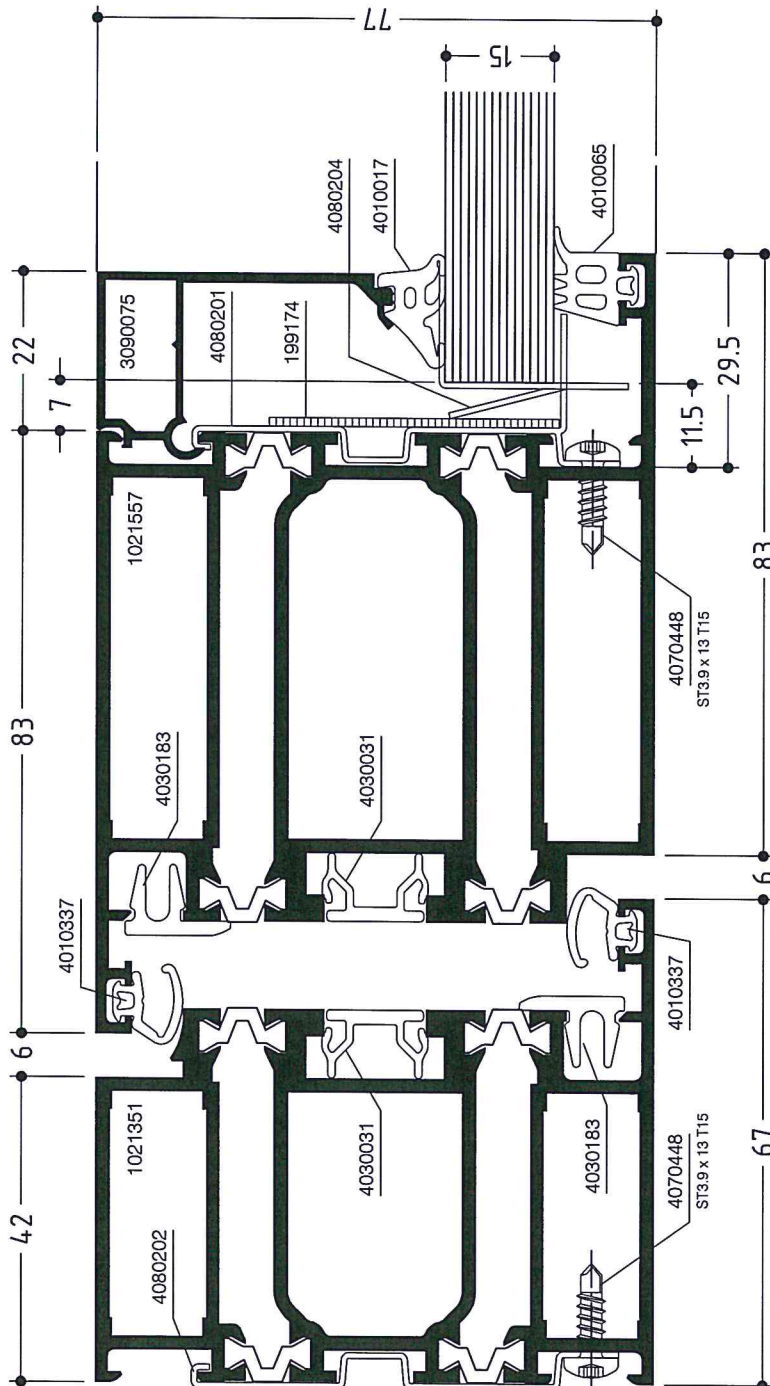
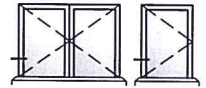

6. APR. 2017



WICSTYLE 77FP

Anschlagtüren einwärts mit Spezialblendrahmen
 Hinged doors inwards with special frame

Konstruktionsschnitt
 Construction section

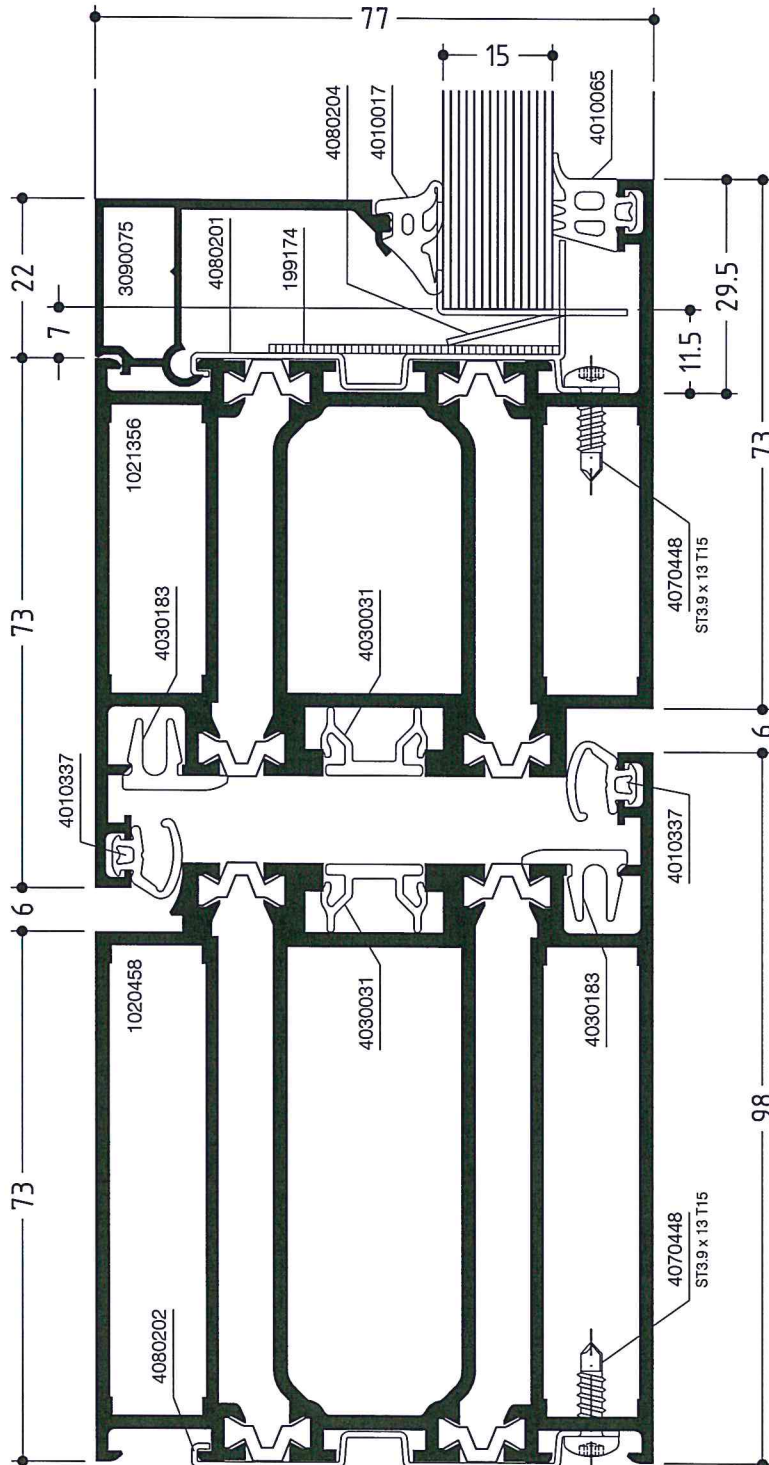
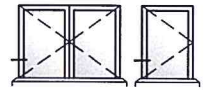

6. APR. 2017



WICSTYLE 77FP

Anschlagtüren auswärts mit Spezialblendrahmen
Hinged doors outwards with special frame

Konstruktionsschnitt
Construction section

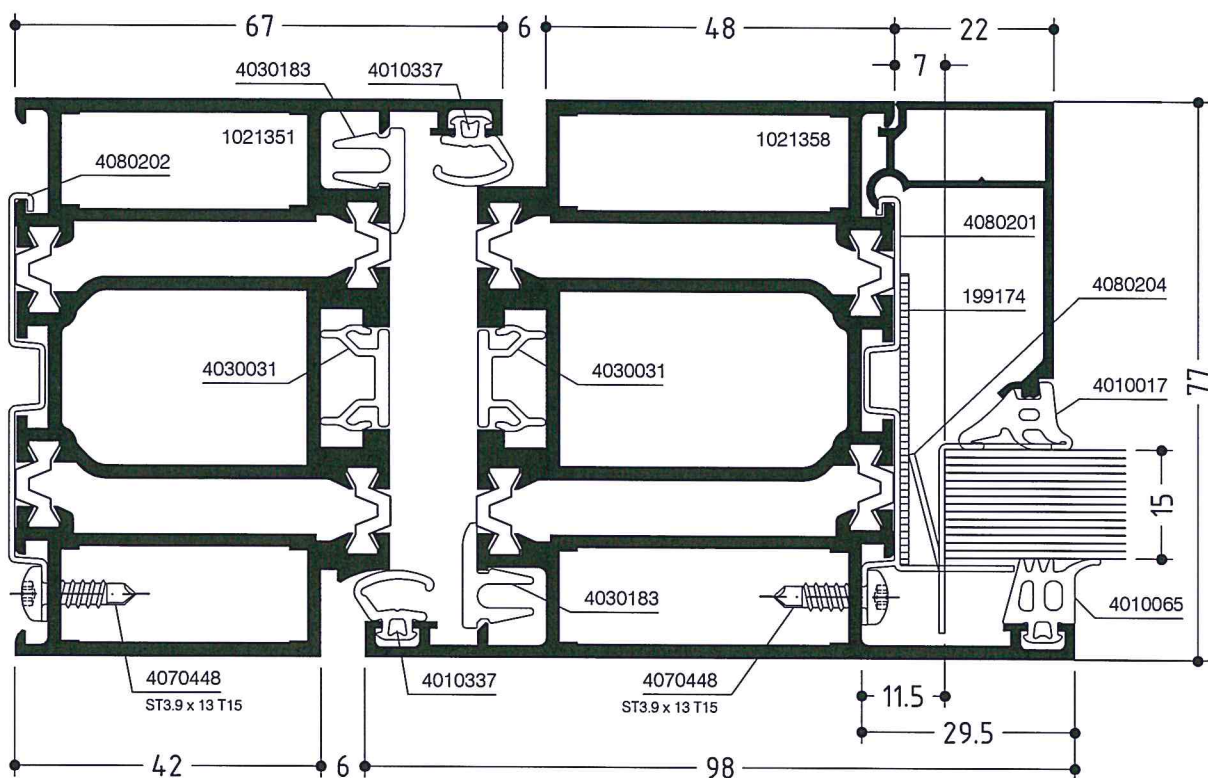
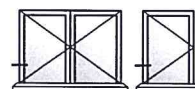

WICSTYLE 77FP

Anschlagtüren auswärts mit Spezialblendrahmen
 Hinged doors outwards with special frame

Konstruktionsschnitt
 Construction section

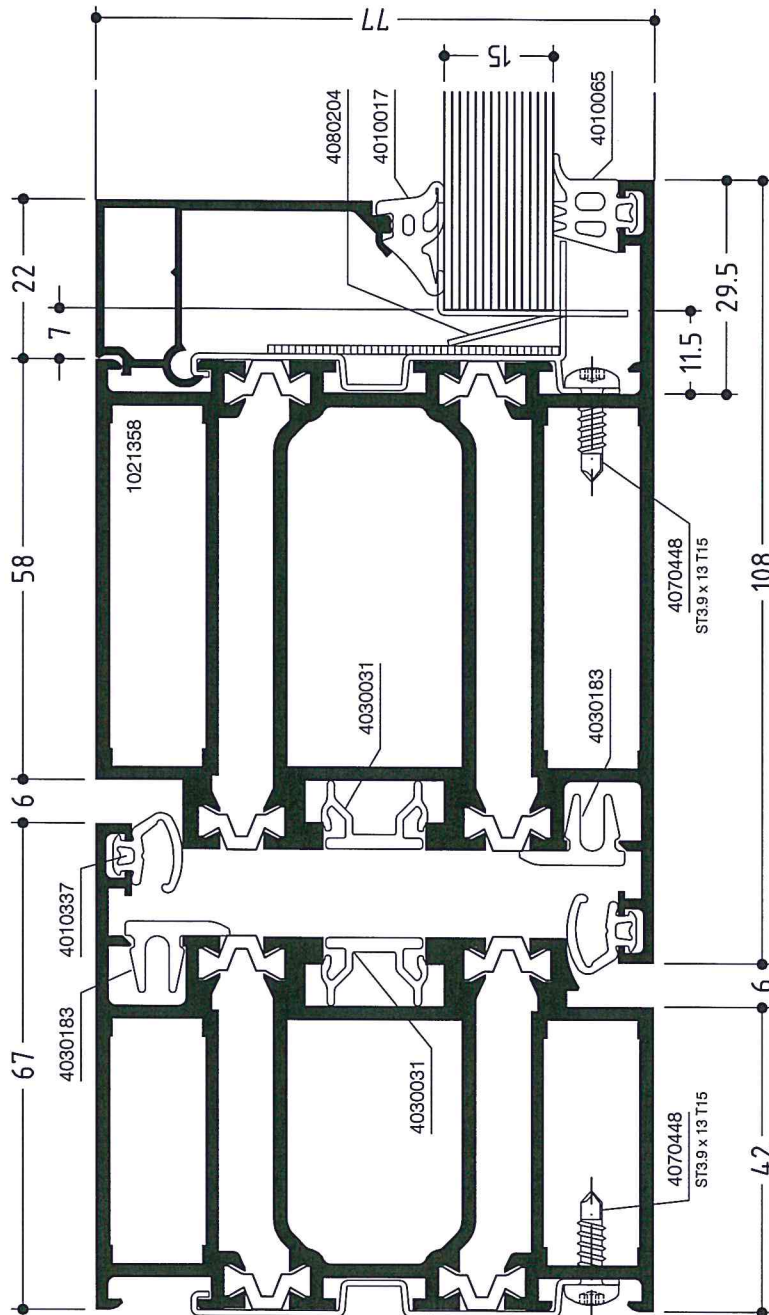
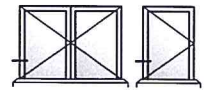

6. APR. 2017

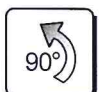

WICSTYLE 77FP

Anschlagtüren auswärts mit seitlicher Verbreiterung
 Hinged doors outwards with lateral widening

Konstruktionsschnitt
 Construction section

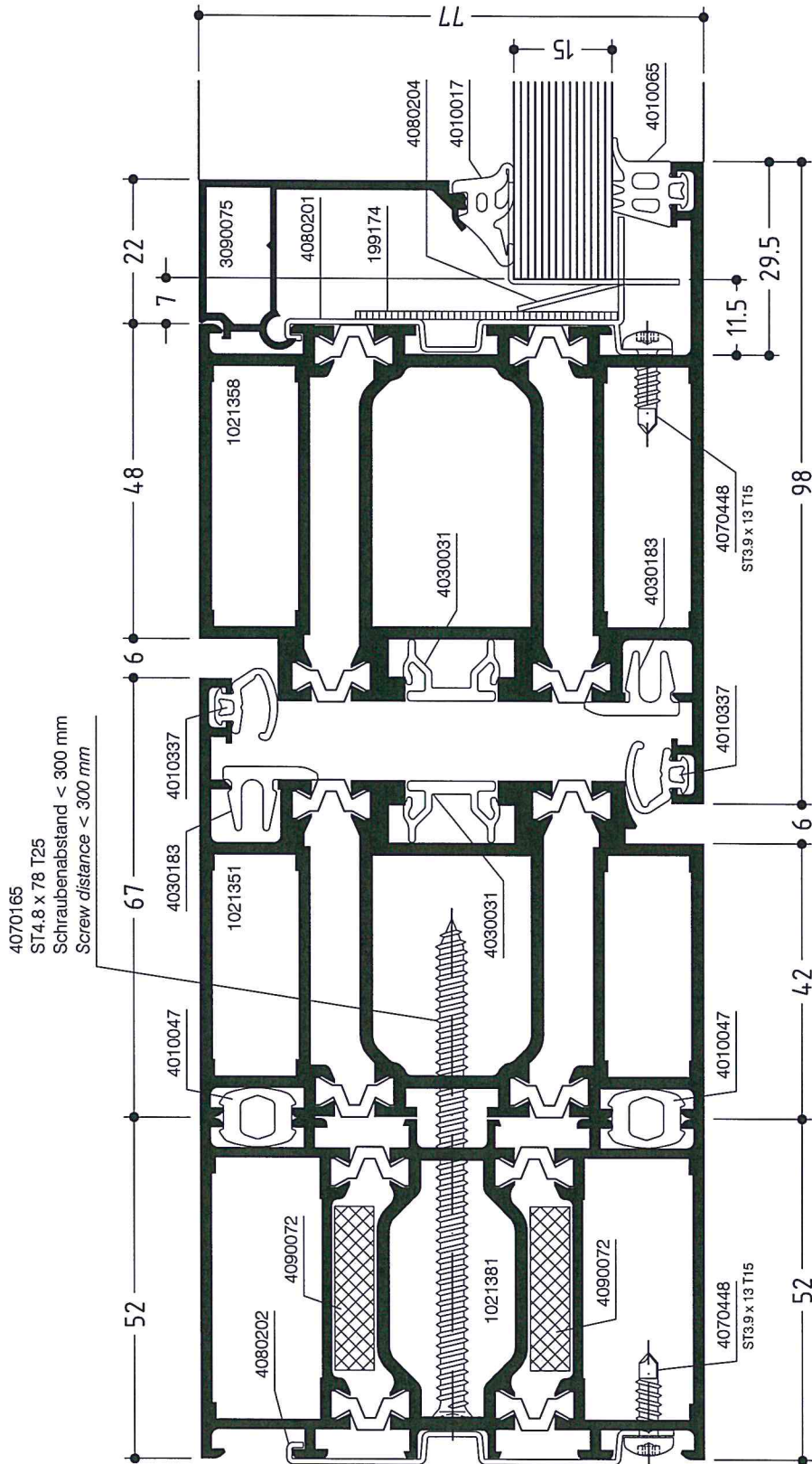
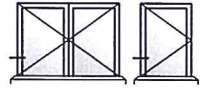

6. APR. 2017



WICSTYLE 77FP

Anschlagtüren auswärts mit Spezialblendrahmen
 Hinged doors outwards with special frame

Konstruktionsschnitt
 Construction section

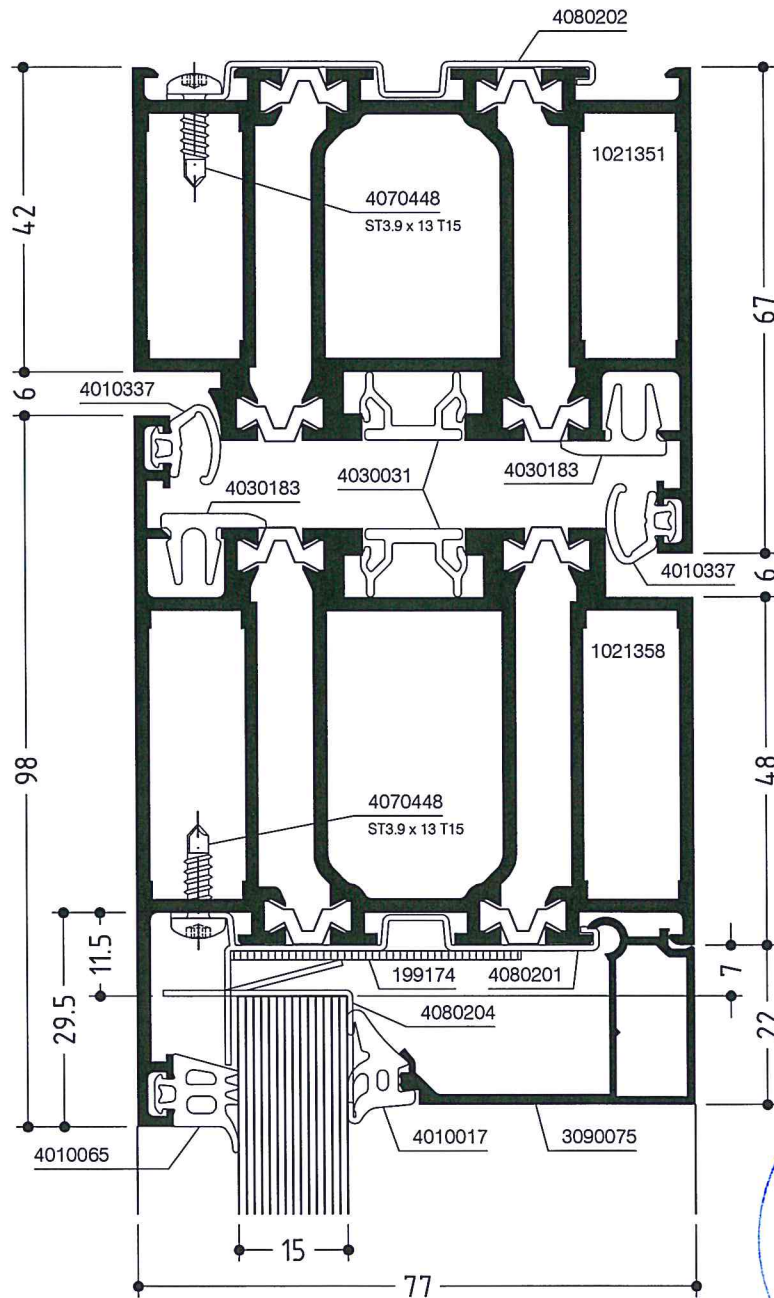
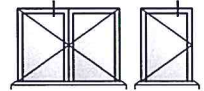

6. APR. 2017

WICSTYLE 77FP

Anschlagtüren auswärts mit Rahmenverbreiterung
 Hinged doors outwards with frame widening profile

Konstruktionsschnitt
 Construction section

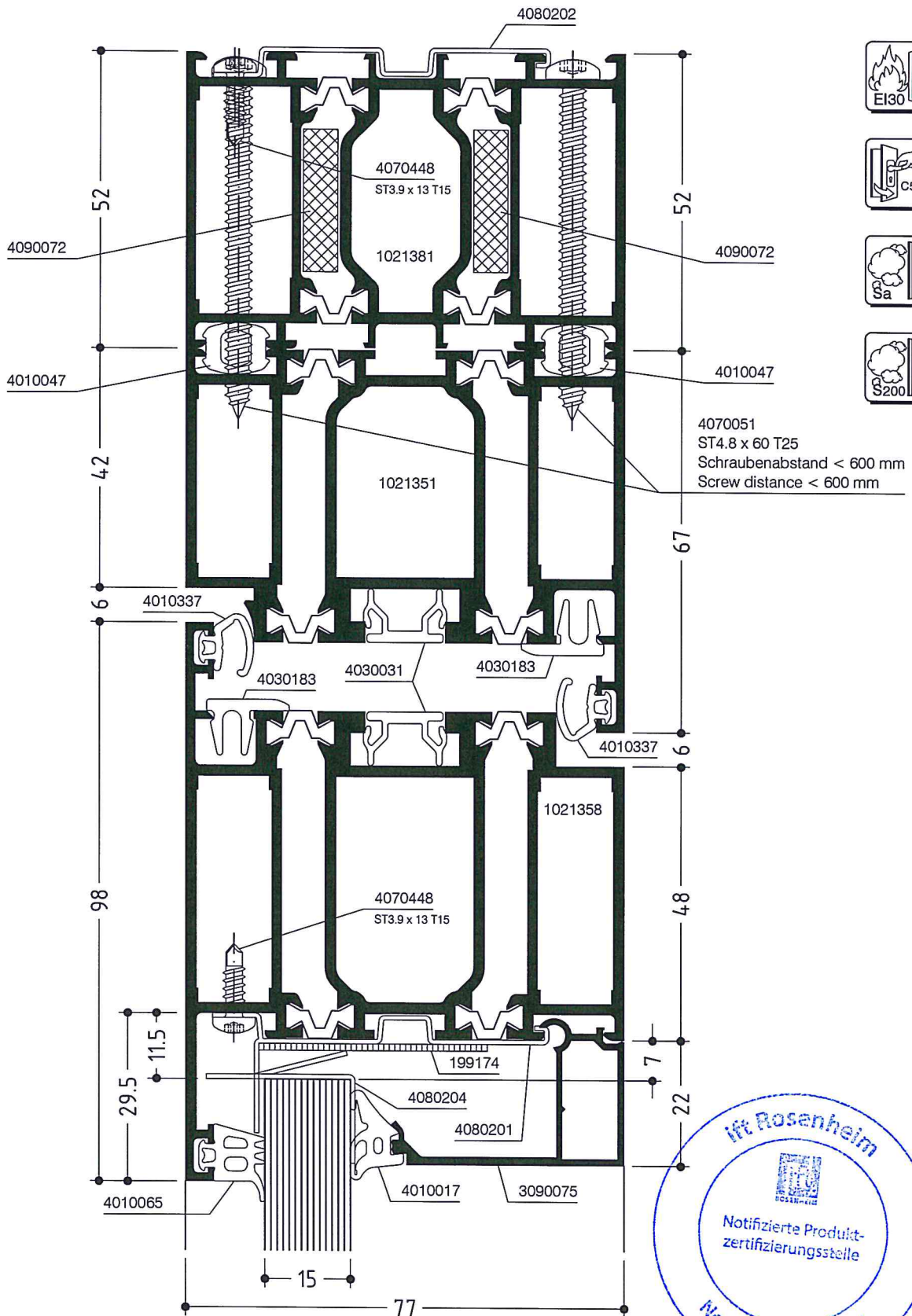
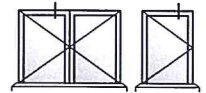

WICSTYLE 77FP

Anschlagtüren auswärts mit Flügelprofil umlaufend
Hinged doors outwards with circumferential leaf profile

Konstruktionsschnitt
Construction section

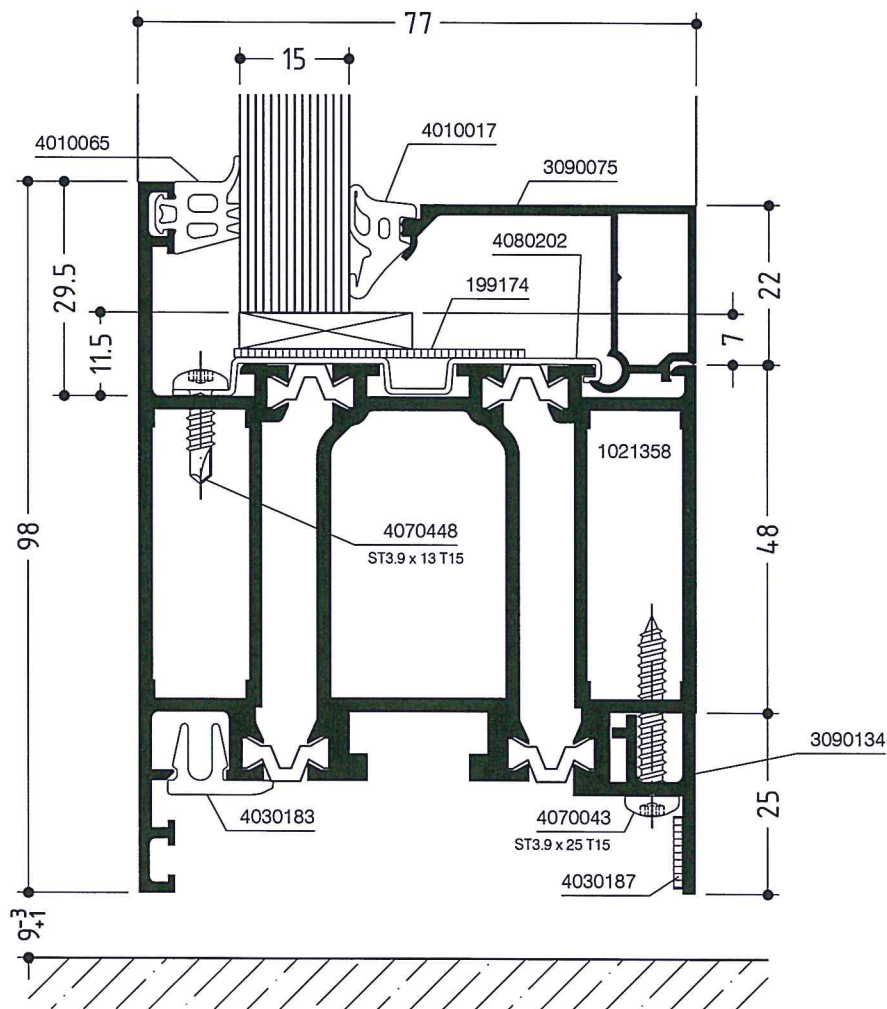
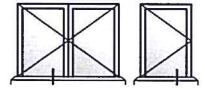

WICSTYLE 77FP

Anschlagtüren auswärts, Sockel mit Verbreiterungsprofil
 Hinged doors outwards, bottom rail with widening profile

Konstruktionsschnitt
 Construction section

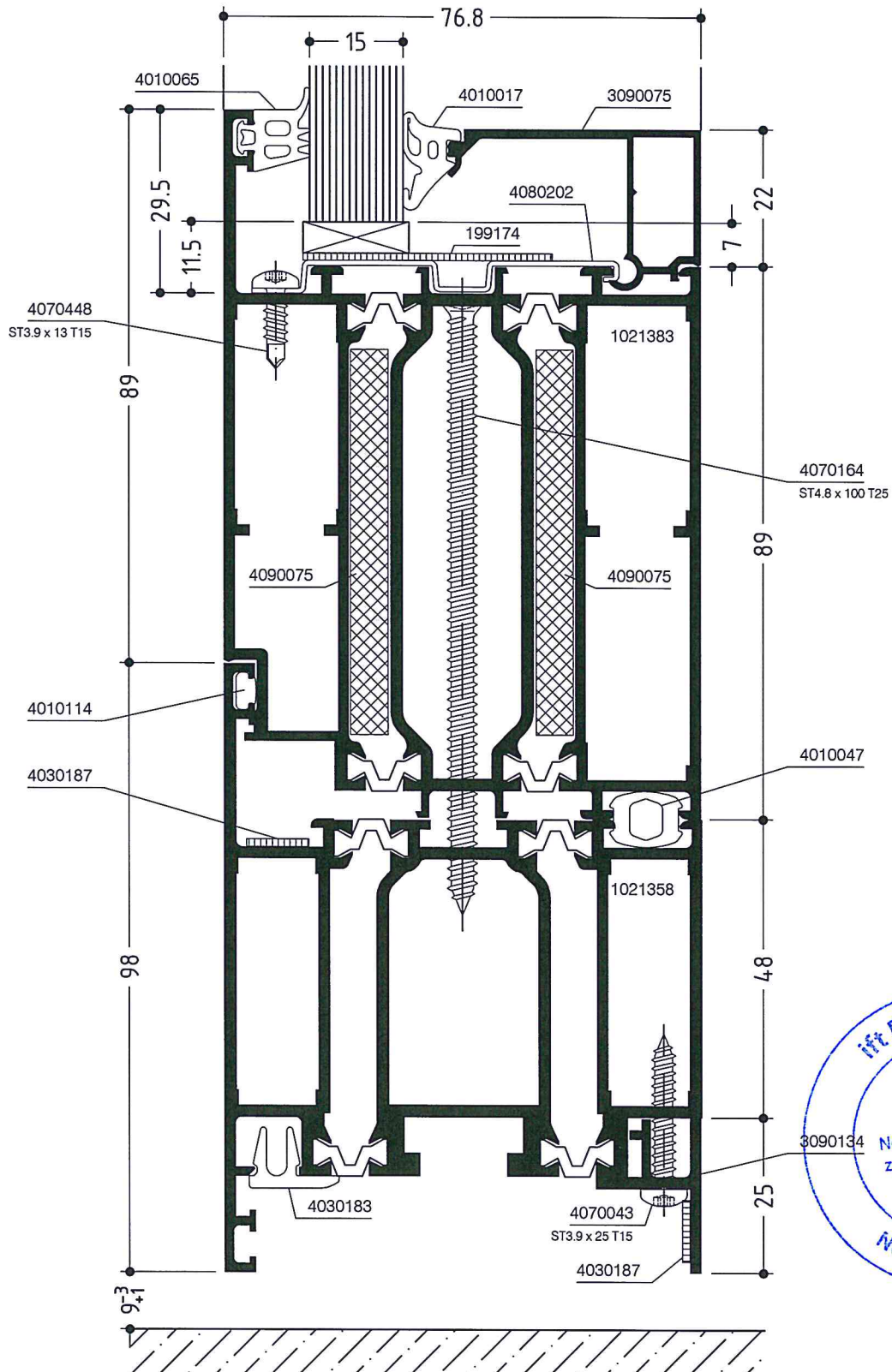
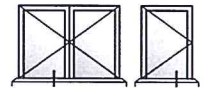

6. APR. 2017

WICSTYLE 77FP

Anschlagtüren einwärts / auswärts mit Sockelprofil
 Hinged doors inwards / outwards with bottom rail profile

Konstruktionsschnitt
 Construction section

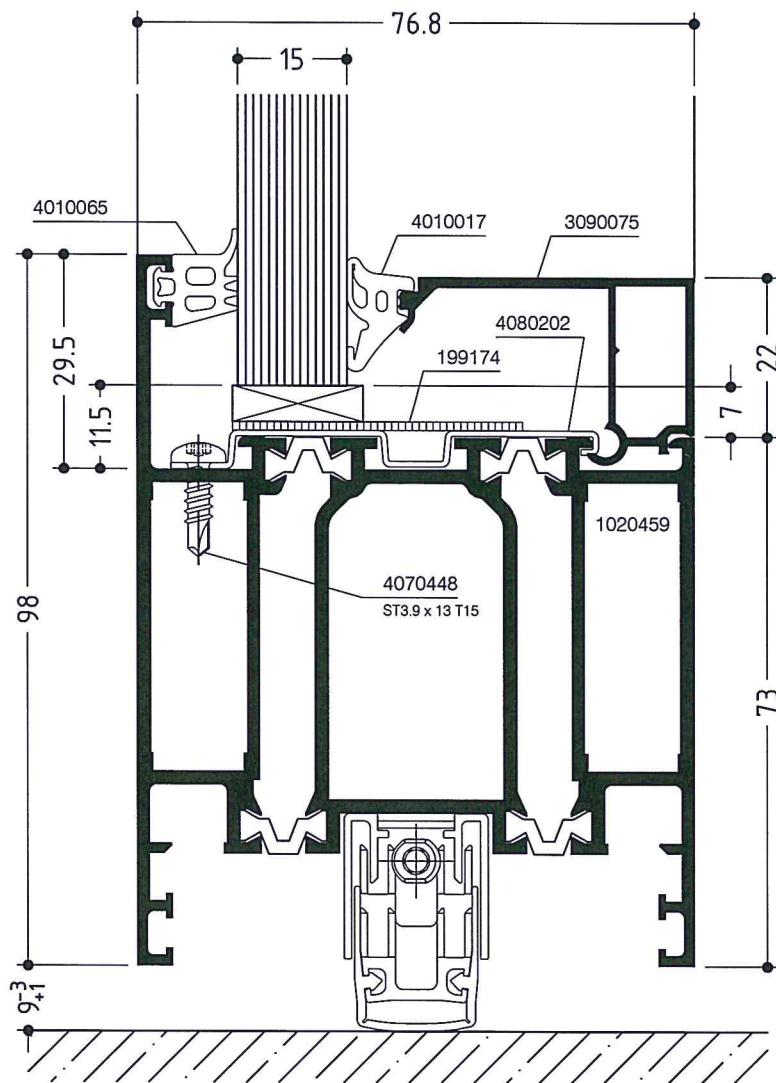
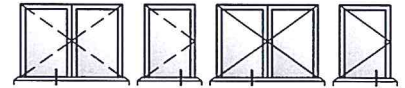

WICSTYLE 77FP

Anschlagtüren einwärts / auswärts mit Sockelprofil
 Hinged doors inwards / outwards with bottom rail profile

Konstruktionsschnitt
 Construction section

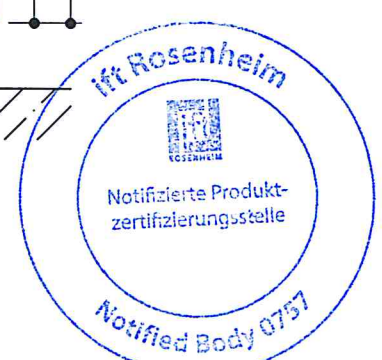
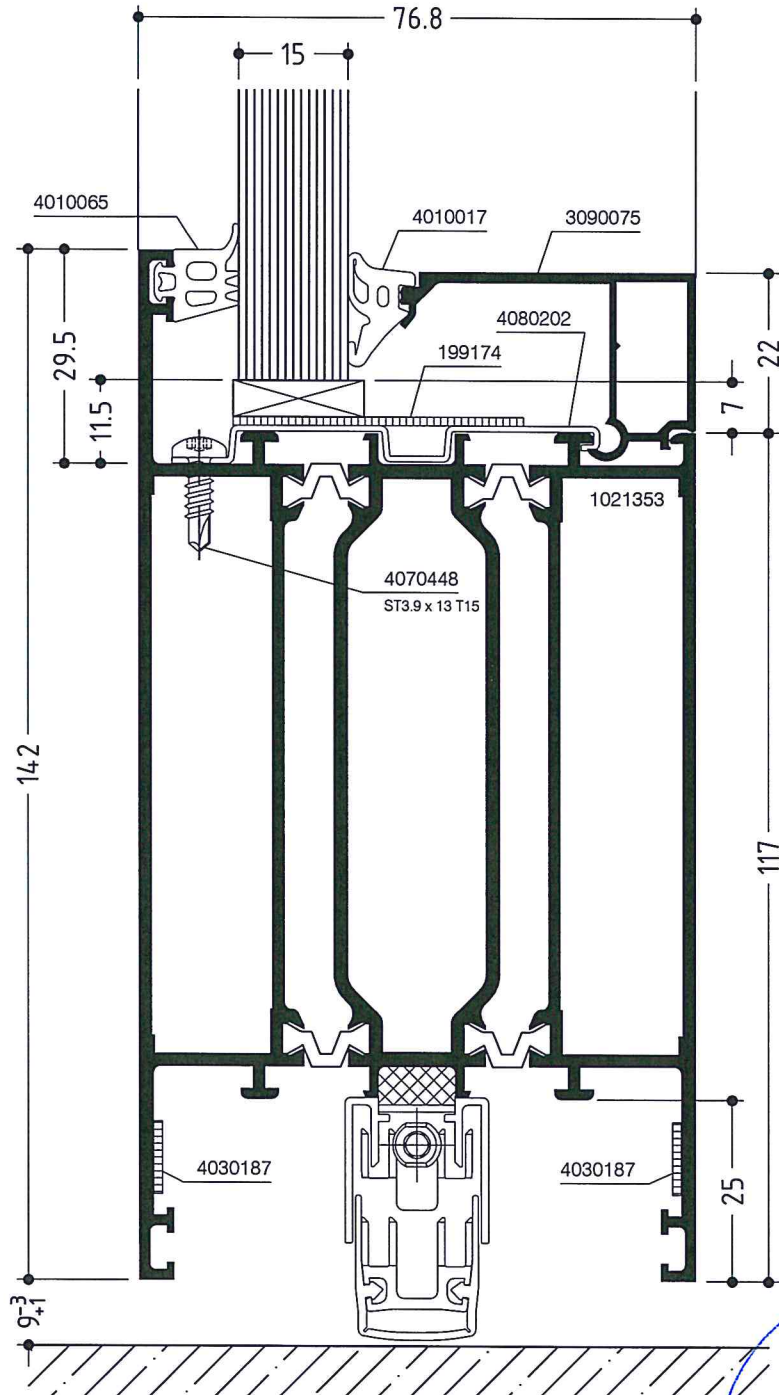
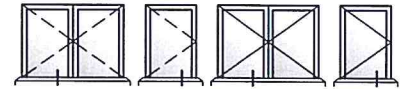

WICSTYLE 77FP

Anschlagtüren einwärts / auswärts mit Sockelprofil
 Hinged doors inwards / outwards with bottom rail profile

Konstruktionsschnitt
 Construction section

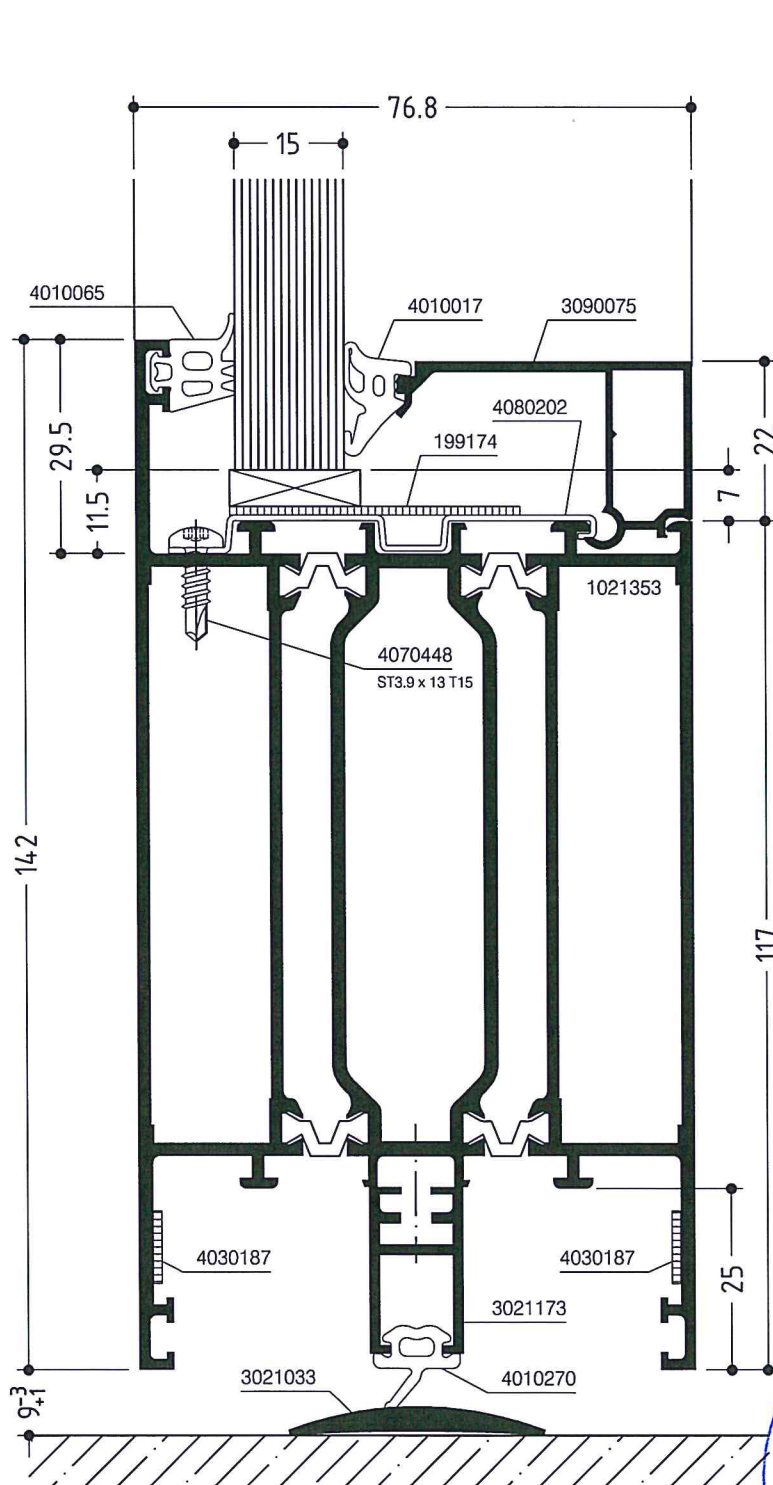
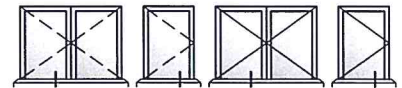

6. APR. 2017

WICSTYLE 77FP

Anschlagtüren einwärts mit Flügelprofil umlaufend
Hinged doors inwards with circumferential leaf profile

Konstruktionsschnitt
Construction section

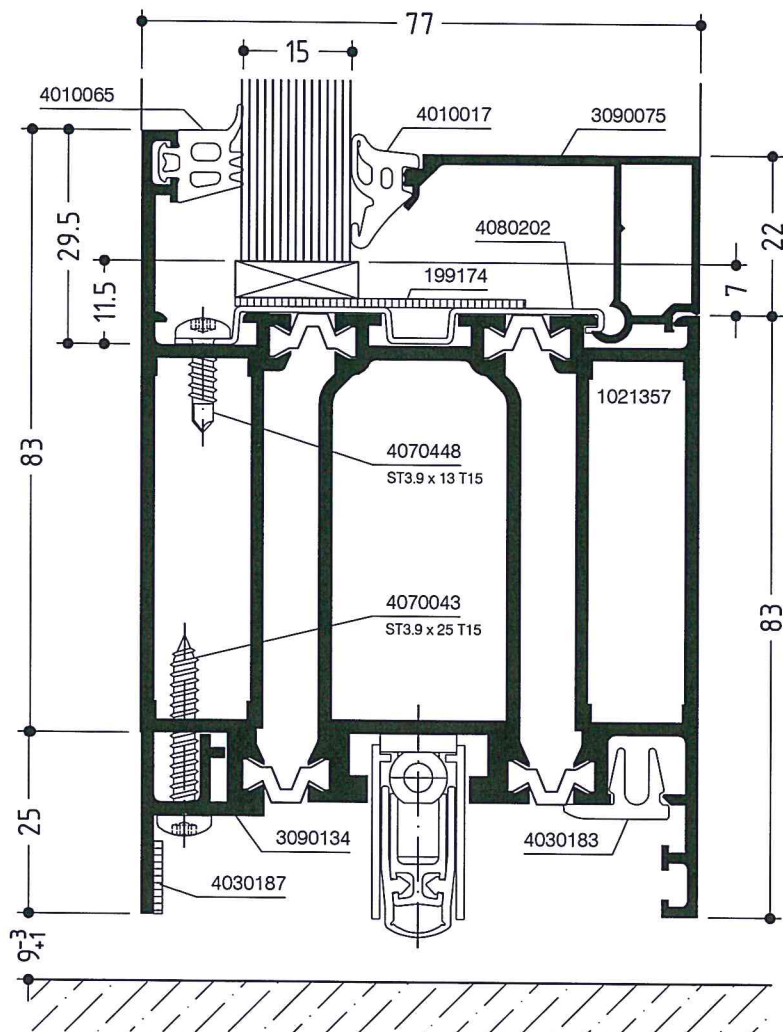
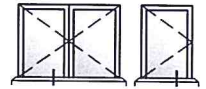

6. APR. 2017

WICSTYLE 77FP

Anschlagtüren einwärts / auswärts mit Sockelprofil
 Hinged doors inwards / outwards with bottom rail profile

Konstruktionsschnitt
 Construction section

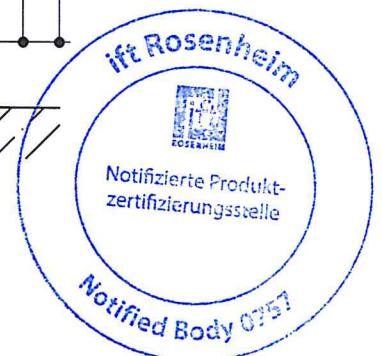
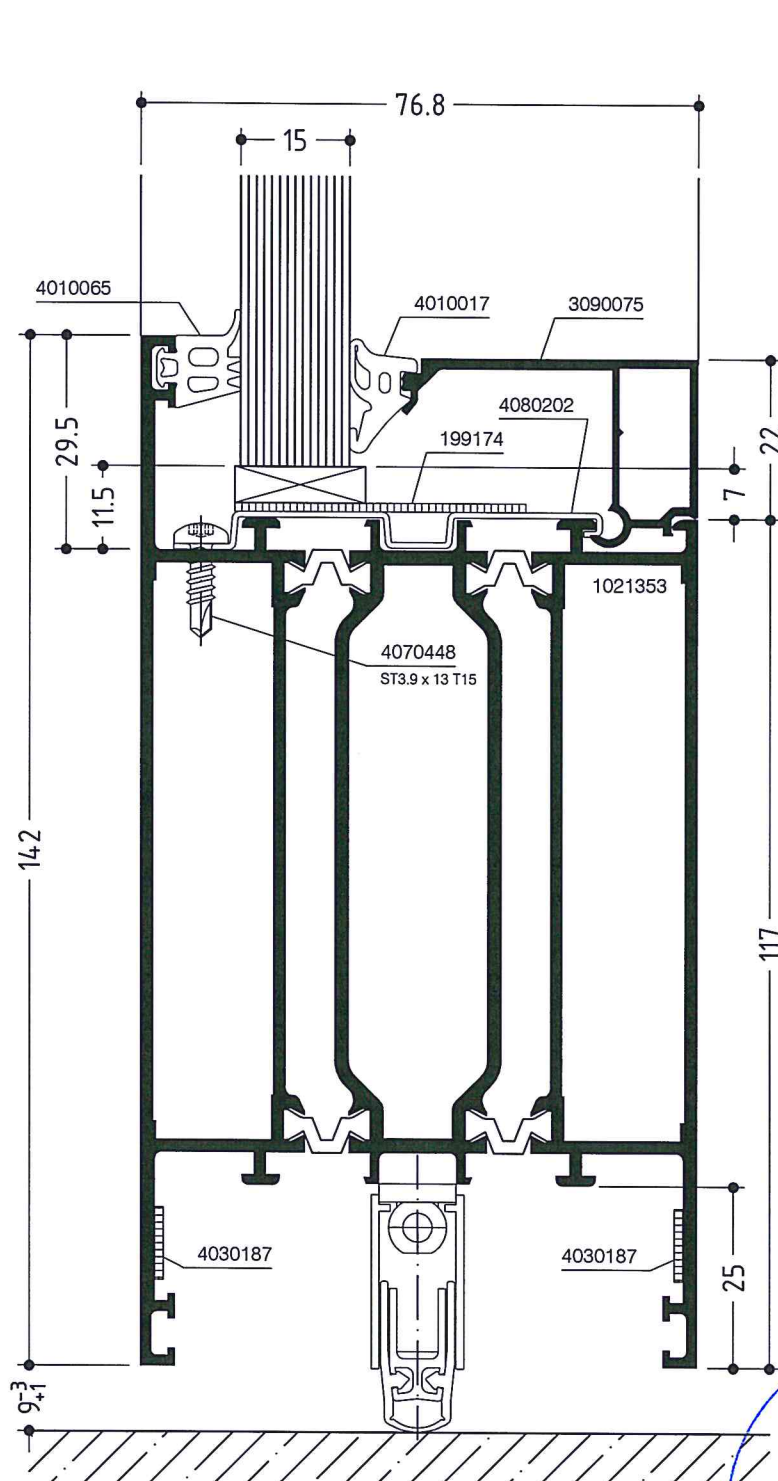
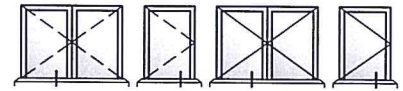

WICSTYLE 77FP

Konstruktionsschnitt

Construction section

Anschlagtüren einwärts / auswärts, Sockel mit Verbreiterungsprofil
 Hinged doors inwards / outwards, bottom rail with widening profile

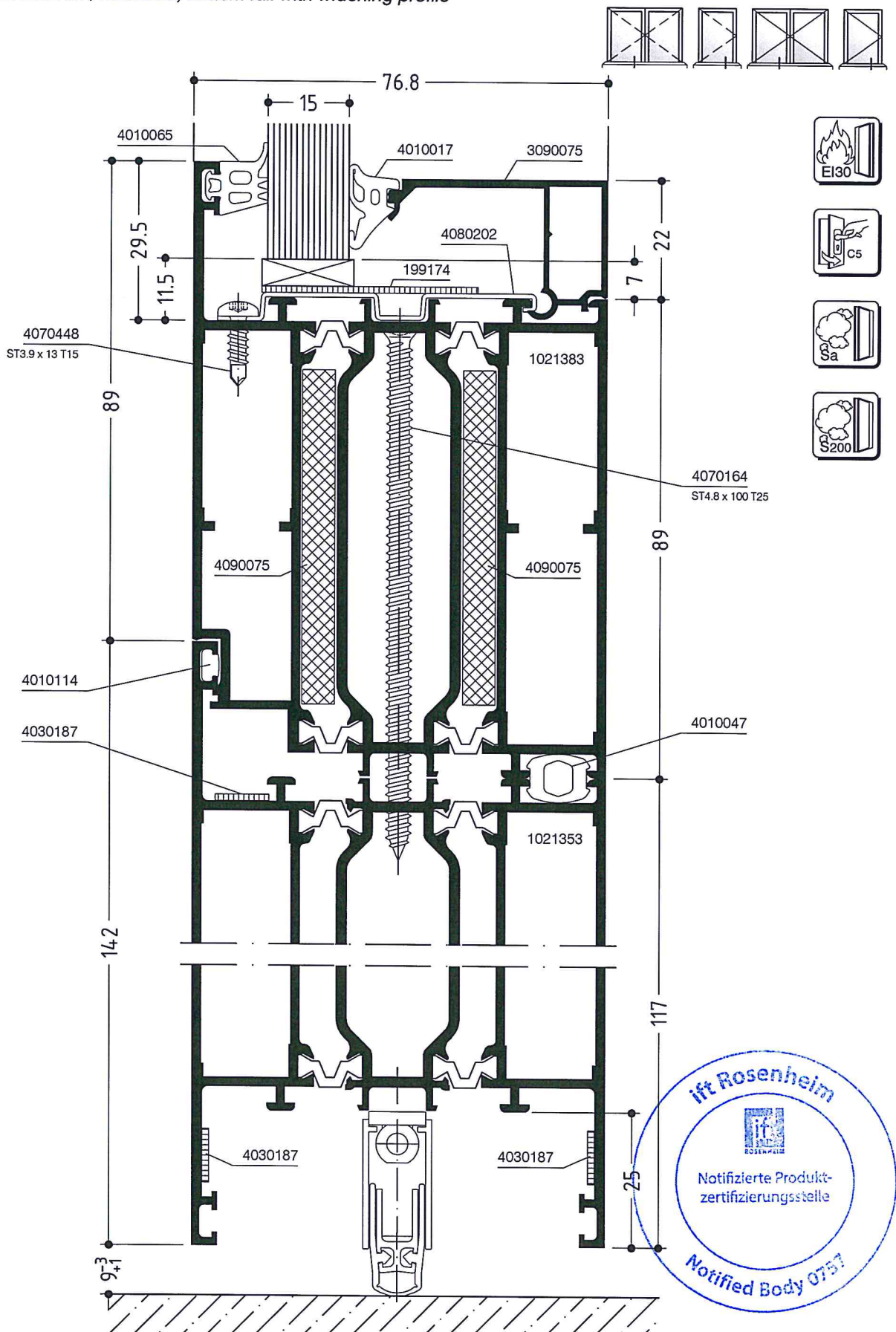

WICSTYLE 77FP

Anschlagtüren einwärts mit Sockelprofil
 Hinged doors inwards with bottom rail profile

Konstruktionsschnitt
 Construction section

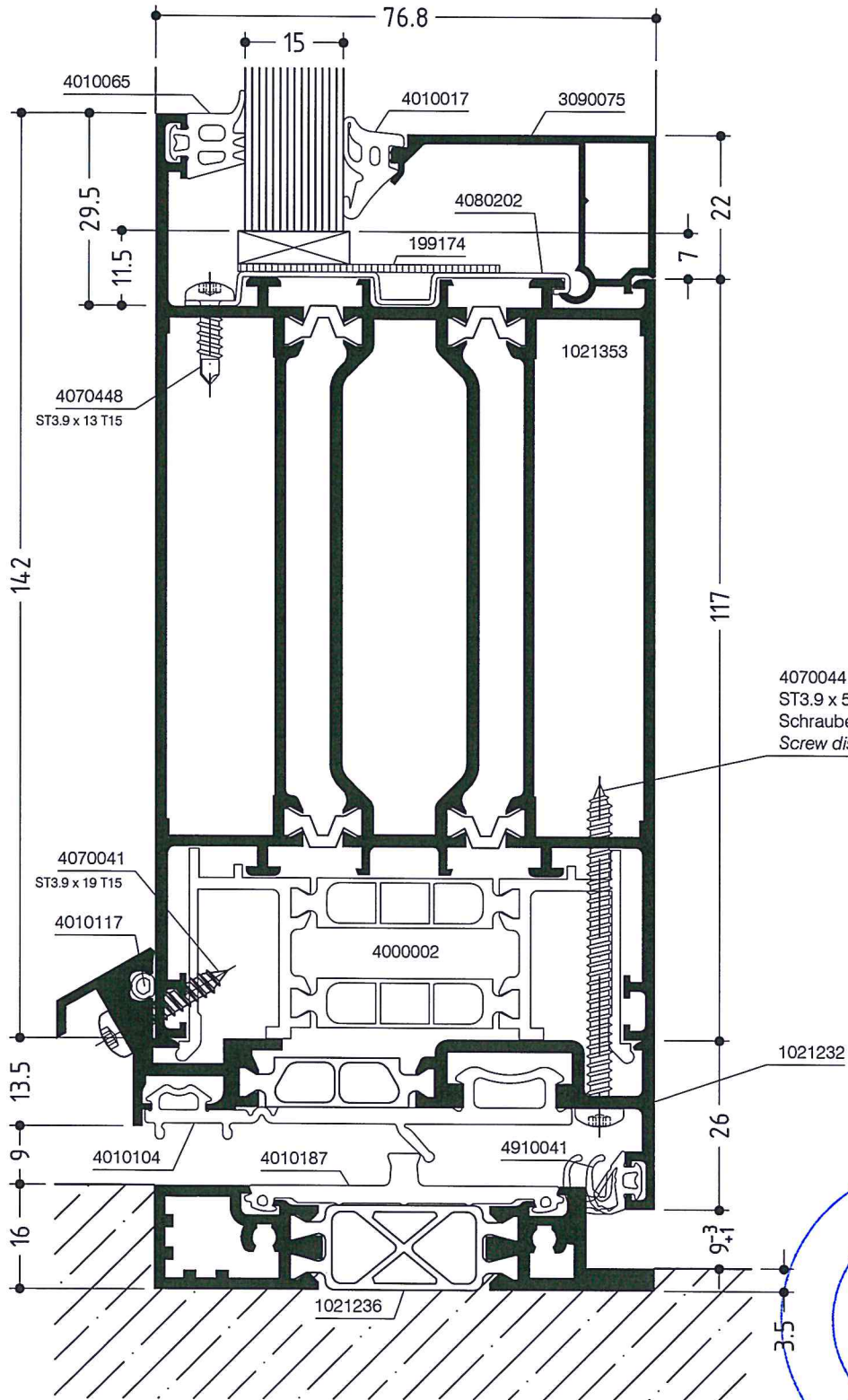
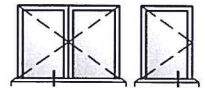

4070044
 ST3.9 x 50 T15
 Schraubenabstand < 400 mm
 Screw distance < 400 mm



WICSTYLE 77FP

Anschlagtüren auswärts mit Sockelprofil
 Hinged doors outwards with bottom rail profile

Konstruktionsschnitt
 Construction section

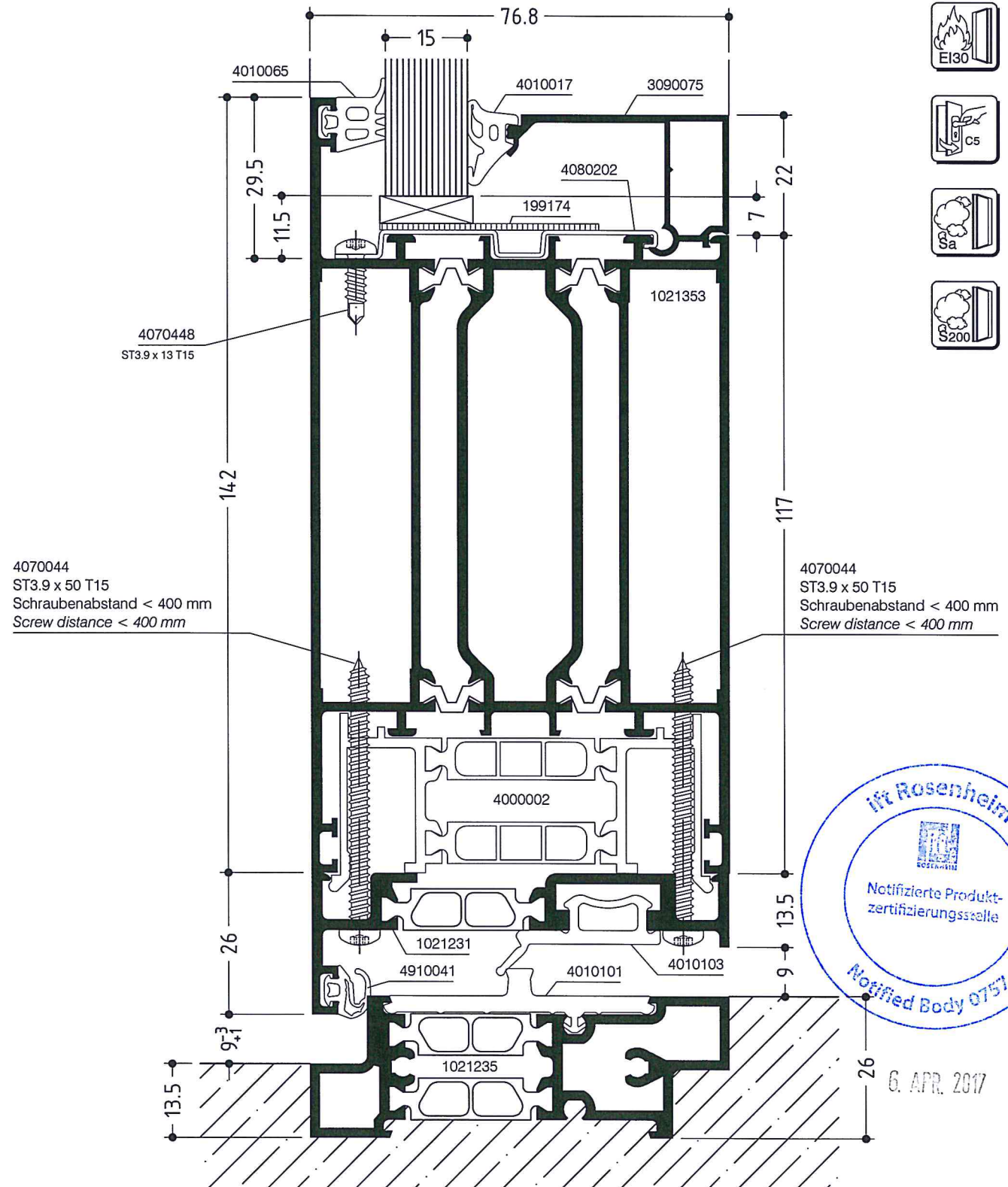
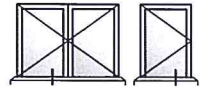

WICSTYLE 77FP

Anschlagtüren einwärts / auswärts mit Sockelprofil
 Hinged doors inwards / outwards with bottom rail profile

Konstruktionsschnitt
 Construction section

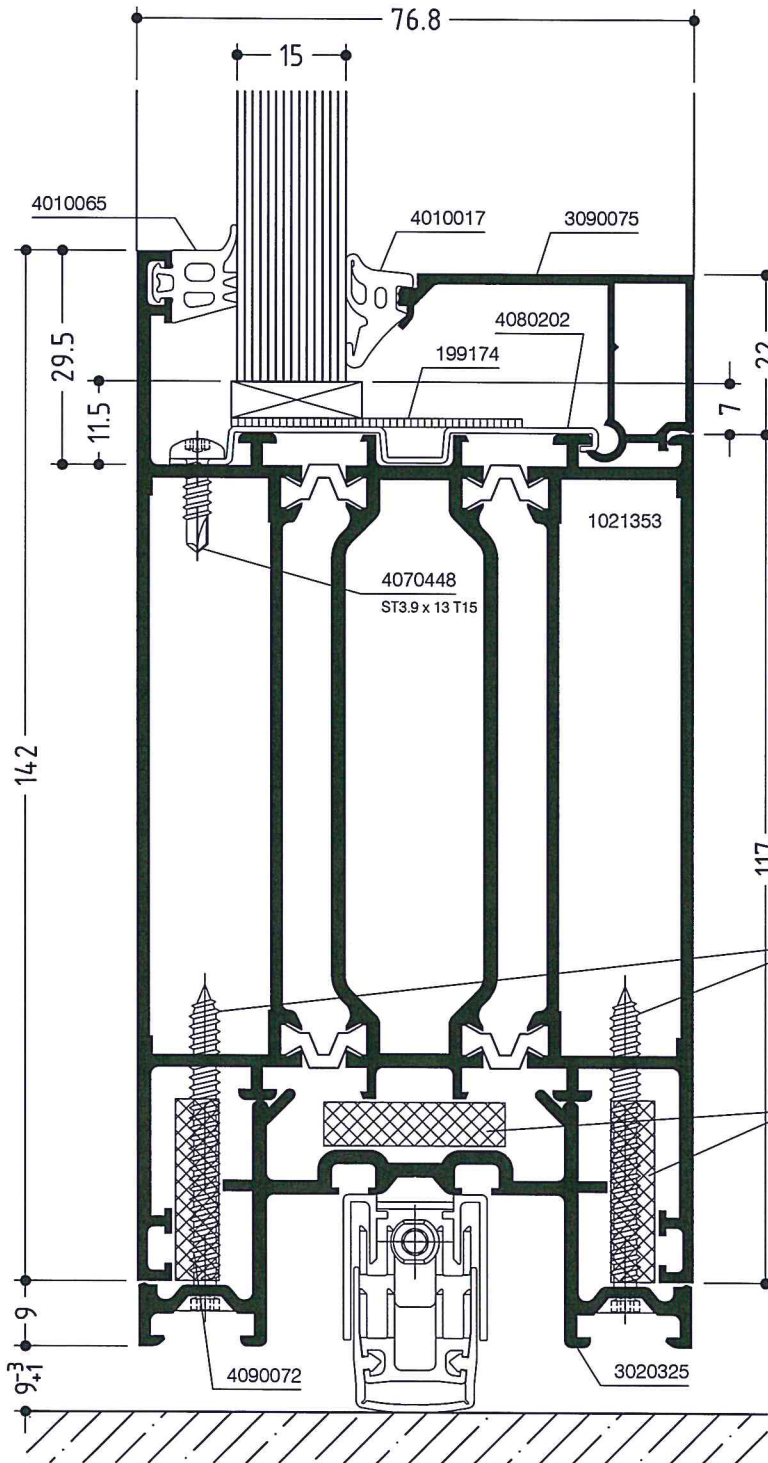
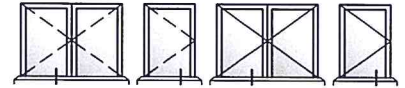

6. APR. 2017

WICSTYLE 77FP

Anschlagtüren einwärts / auswärts, Mittelstoß
 Hinged doors inwards / outwards, meeting stiles

Konstruktionsschnitt
 Construction section

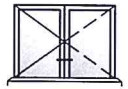
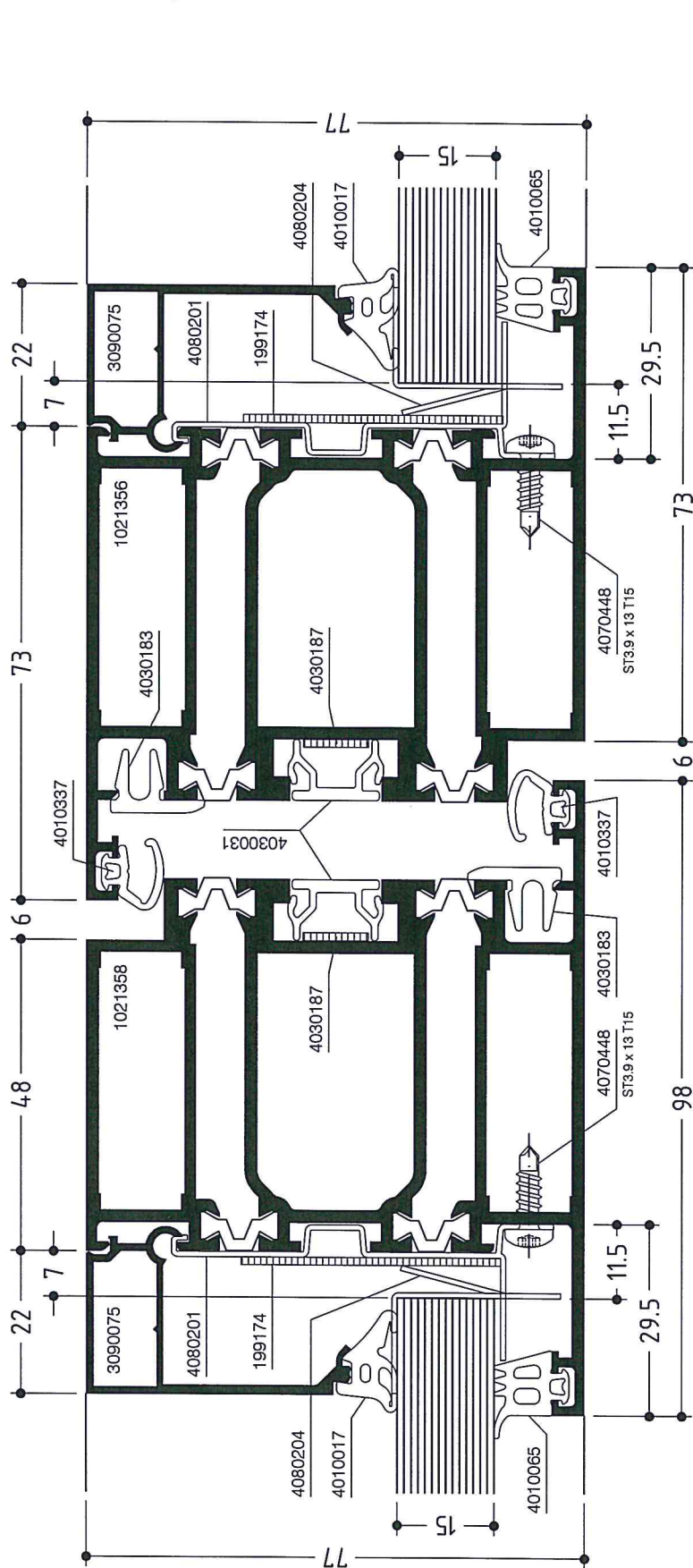

6. APR. 2017



WICSTYLE 77FP

Ansclagtüren einwärts / auswärts, Mittelstoß
 Hinged doors inwards / outwards, meeting stiles

Konstruktionsschnitt
 Construction section

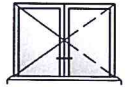
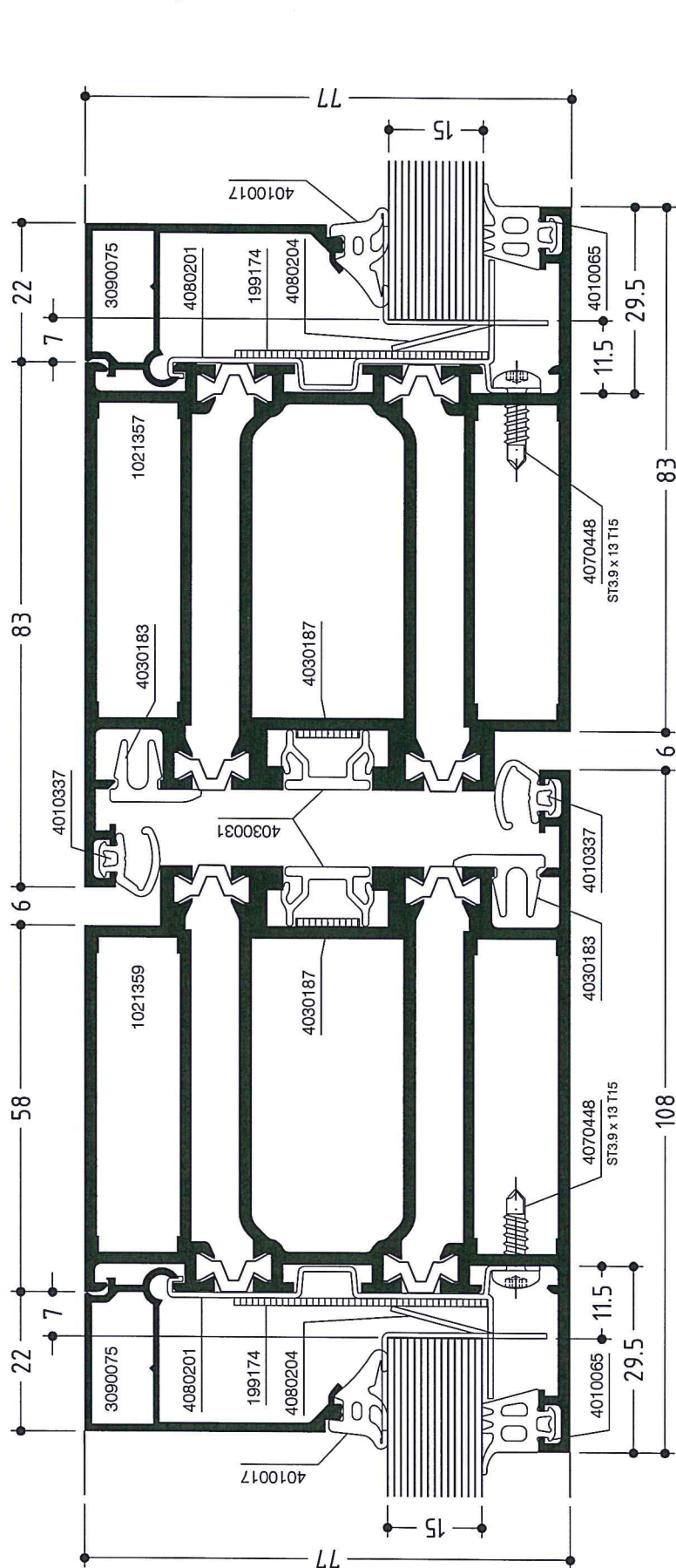

6. APR. 2017



WICSTYLE 77FP

Anschlagtüren einwärts/ auswärts, Mittelstoß
 Hinged doors inwards/ outwards, meeting stiles

Konstruktionsschnitt
 Construction section

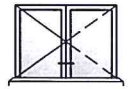
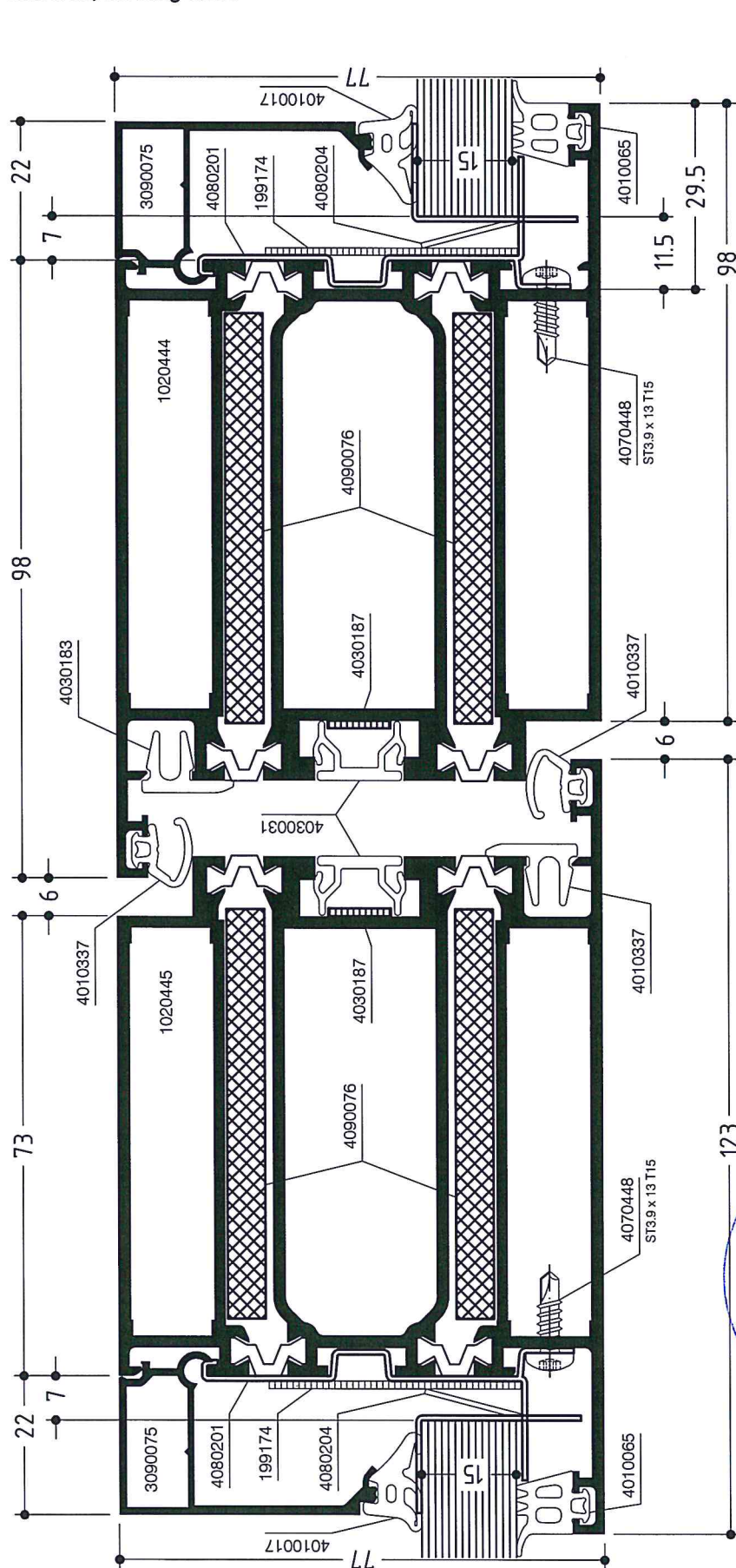

18. AUG. 2017



WICSTYLE 77FP

Anschlagtüren einwärts mit Oberlicht-Festfeld
 Hinged doors inwards with fixed fanlight

Konstruktionsschnitt
 Construction section

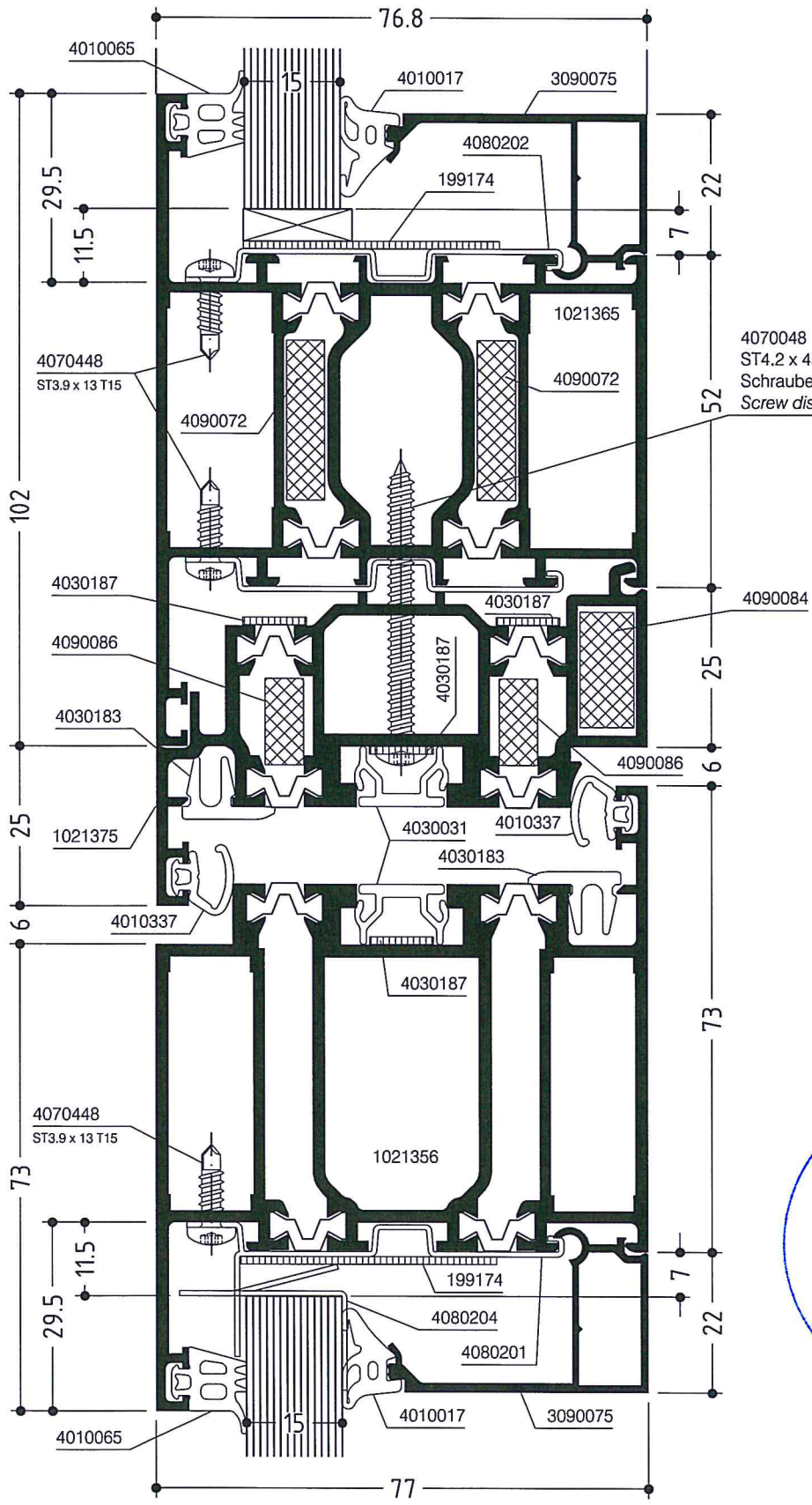
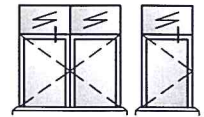

6. APR. 2017

WICSTYLE 77FP

Anschlagtüren einwärts mit Oberlicht-Festelement
 Hinged doors inwards with fixed fanlight

Konstruktionsschnitt
 Construction section

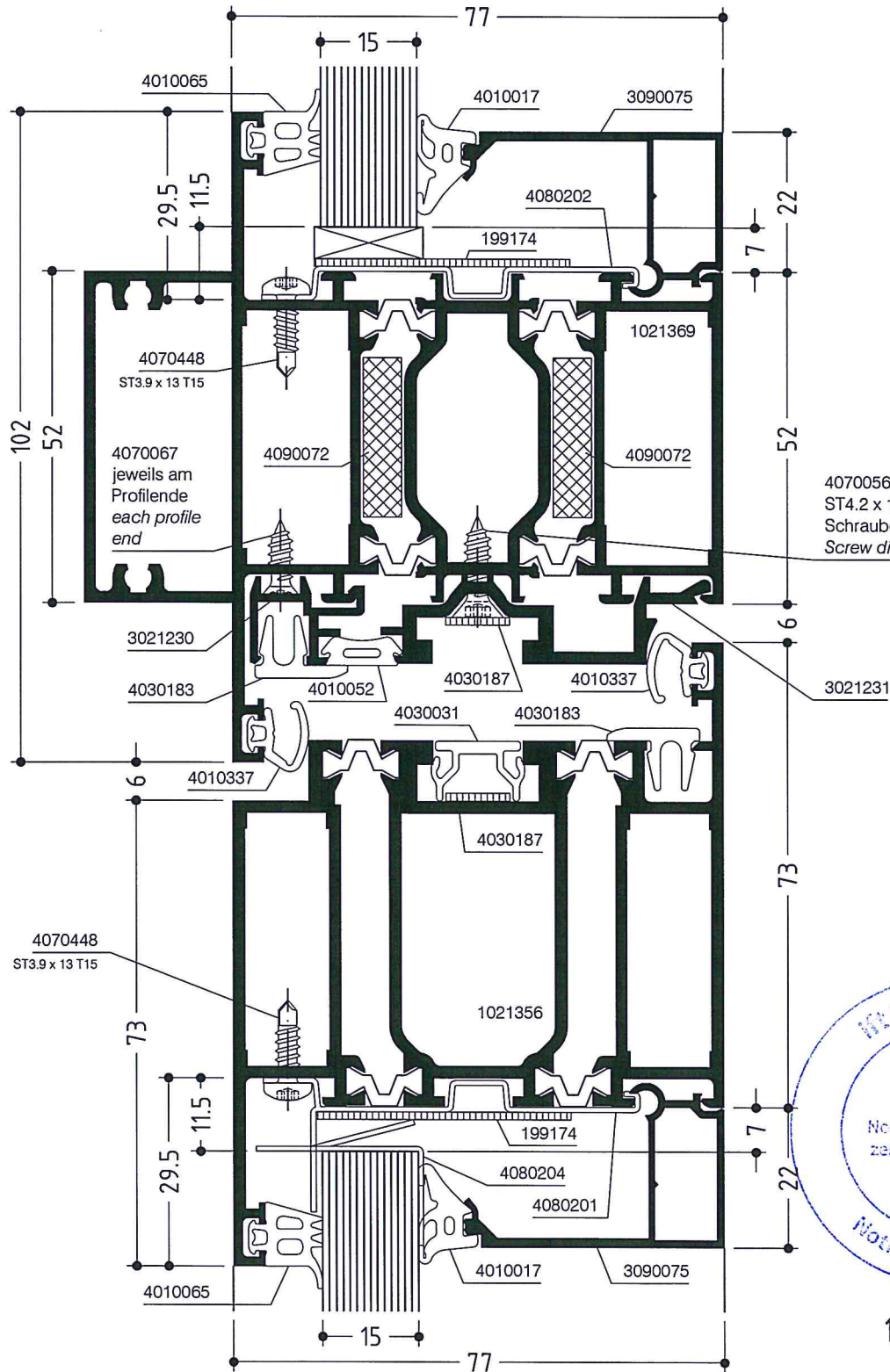
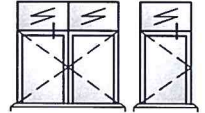

4070056
 ST4.2 x 16 T20
 Schraubenabstand < 300 mm
 Screw distance < 300 mm



18. AUG. 2017

WICSTYLE 77FP

Anschlagtüren einwärts mit Oberlicht-Festelement
Hinged doors inwards with fixed fanlight

Konstruktionsschnitt
Construction section

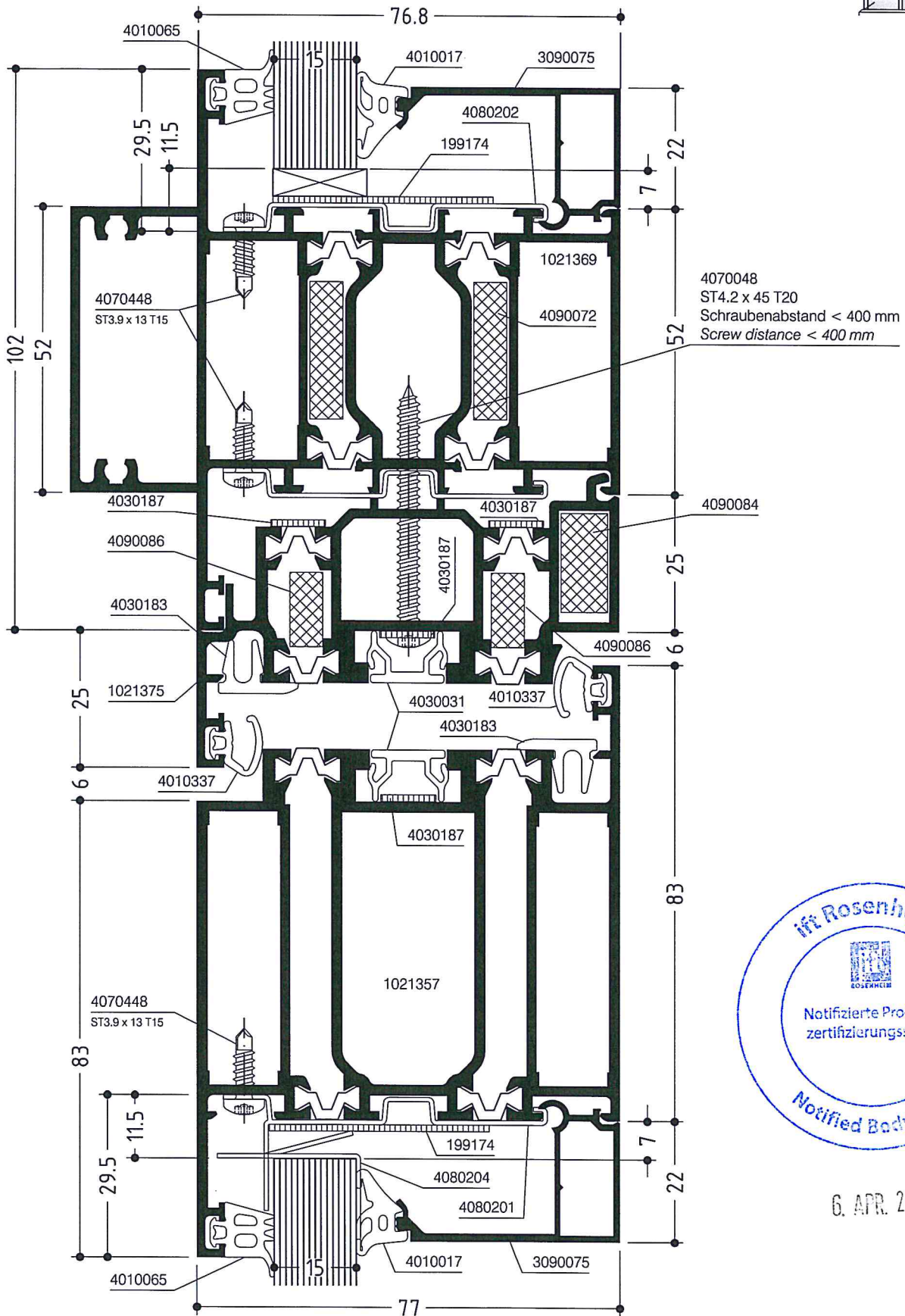
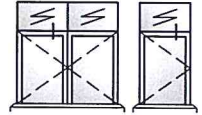

6. APR. 2017

WICSTYLE 77FP

Anschlagtüren auswärts mit Kombinationsblendrahmen
 Hinged doors outwards with combination frame

Konstruktionsschnitt
 Construction section

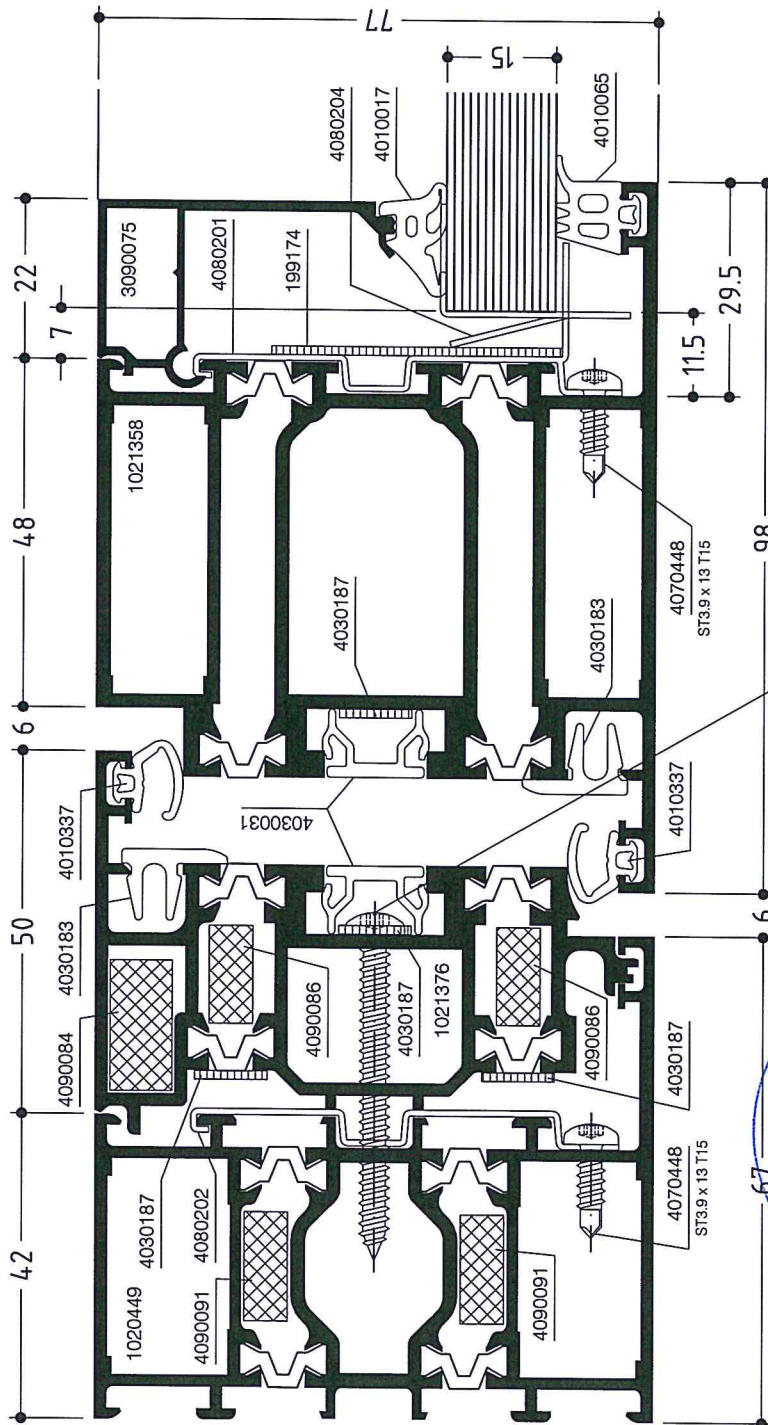
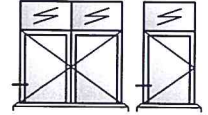

4070048
 ST4.2 x 45 T20
 Schraubenabstand < 400 mm
 Screw distance < 400 mm



6. APR. 2017



WICSTYLE 77FP

Anschlagtüren auswärts mit Kombinationsblendrahmen
 Hinged doors outwards with combination frame

Konstruktionsschnitt
 Construction section

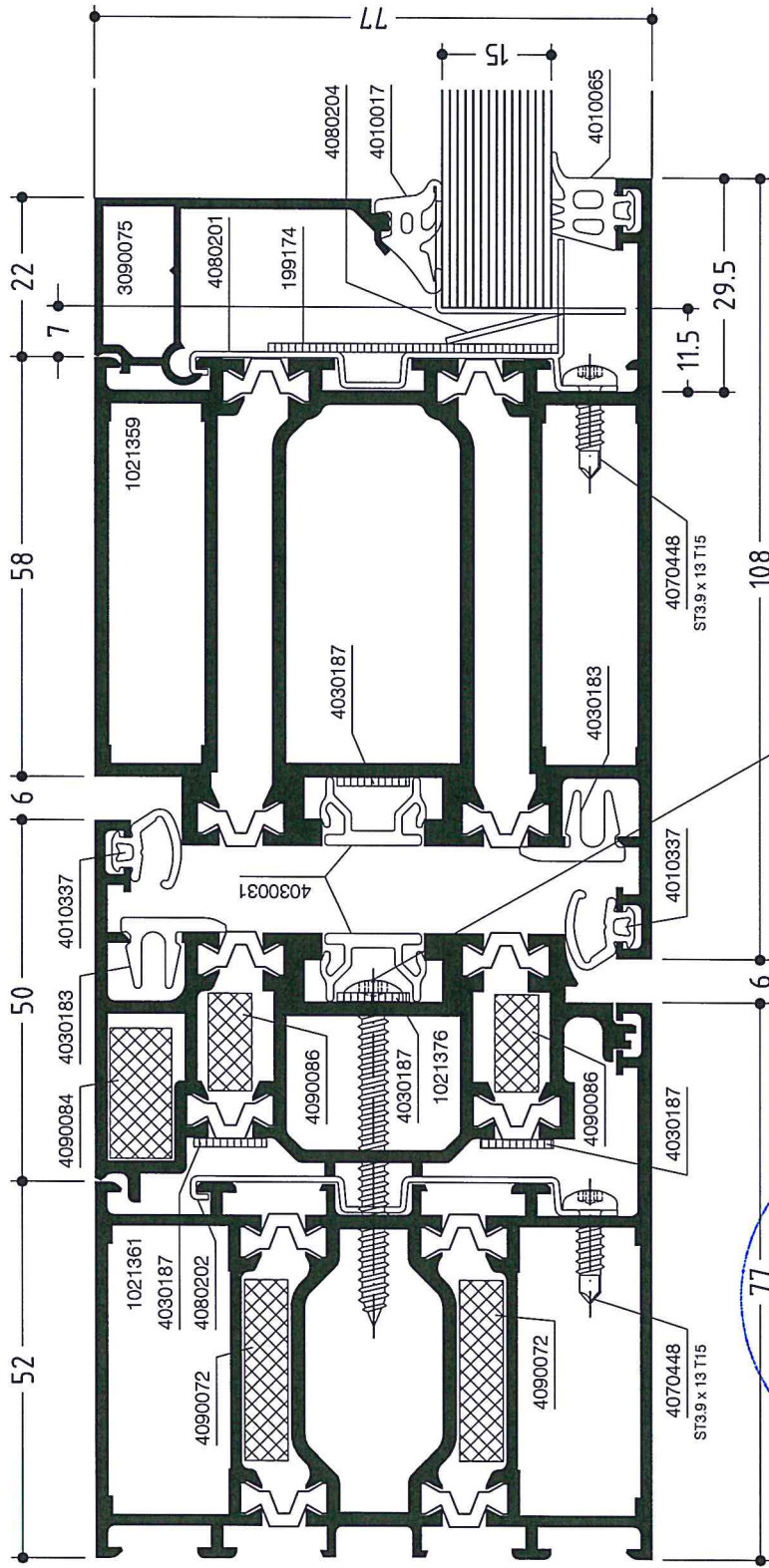
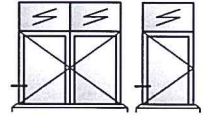

4070048
 ST4,2 x 45 T20
 Schraubenabstand < 400 mm
 Screw distance < 400 mm

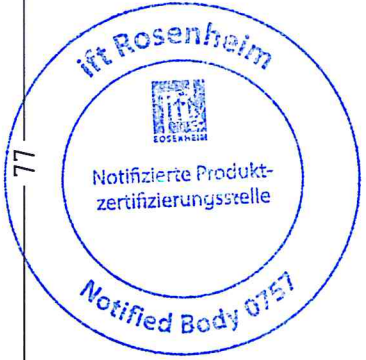
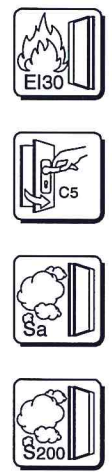

6. APR. 2017



WICSTYLE 77FP

Anschlagtüren einwärts mit Kombinationsblendrahmen
Hinged doors inwards with combination frame

Konstruktionsschnitt
Construction section

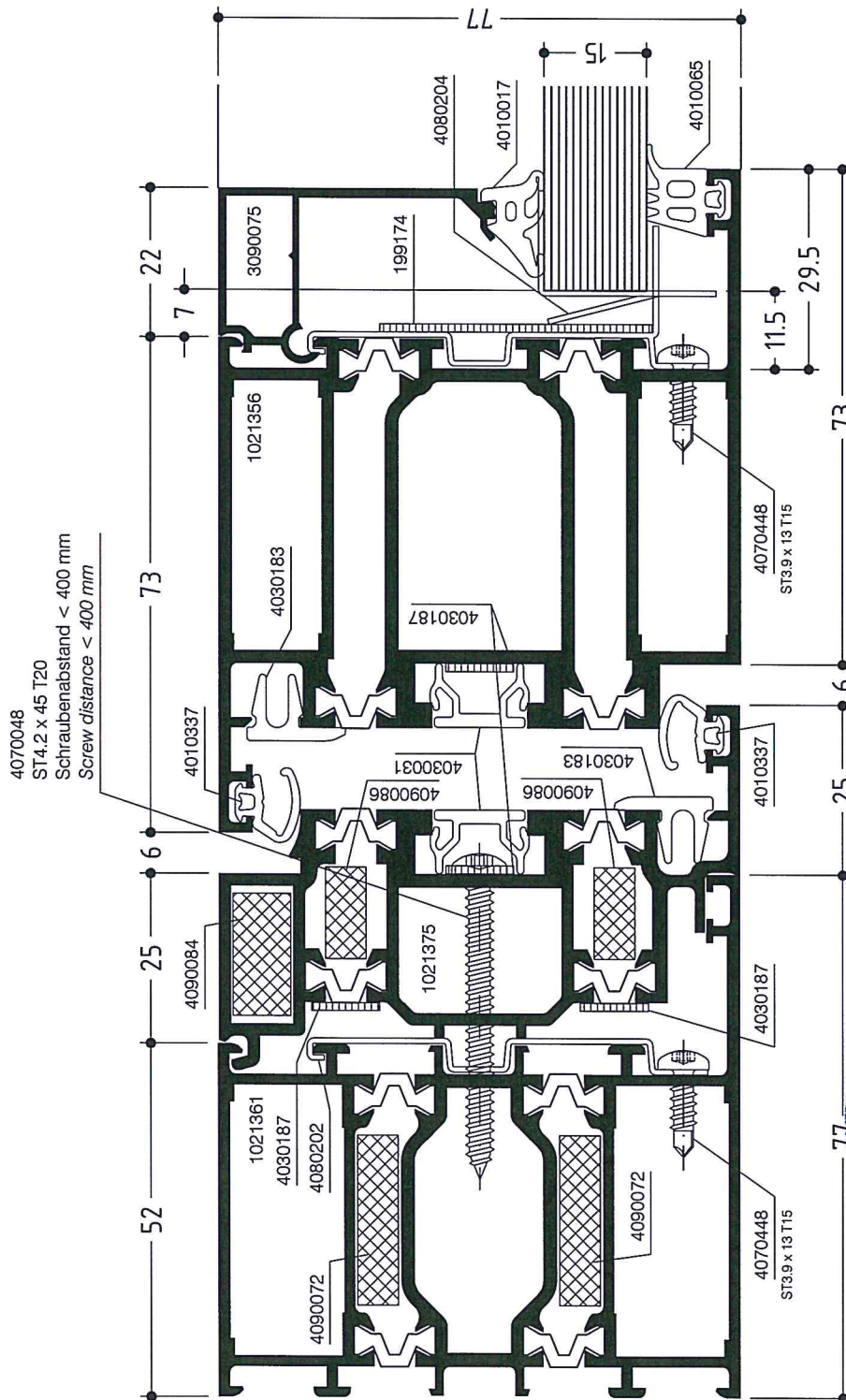
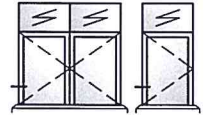

6. APR. 2017



WICSTYLE 77FP

Anschlagtüren einwärts mit Kombinationsblendrahmen
 Hinged doors inwards with combination frame

Konstruktionsschnitt
 Construction section

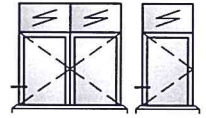
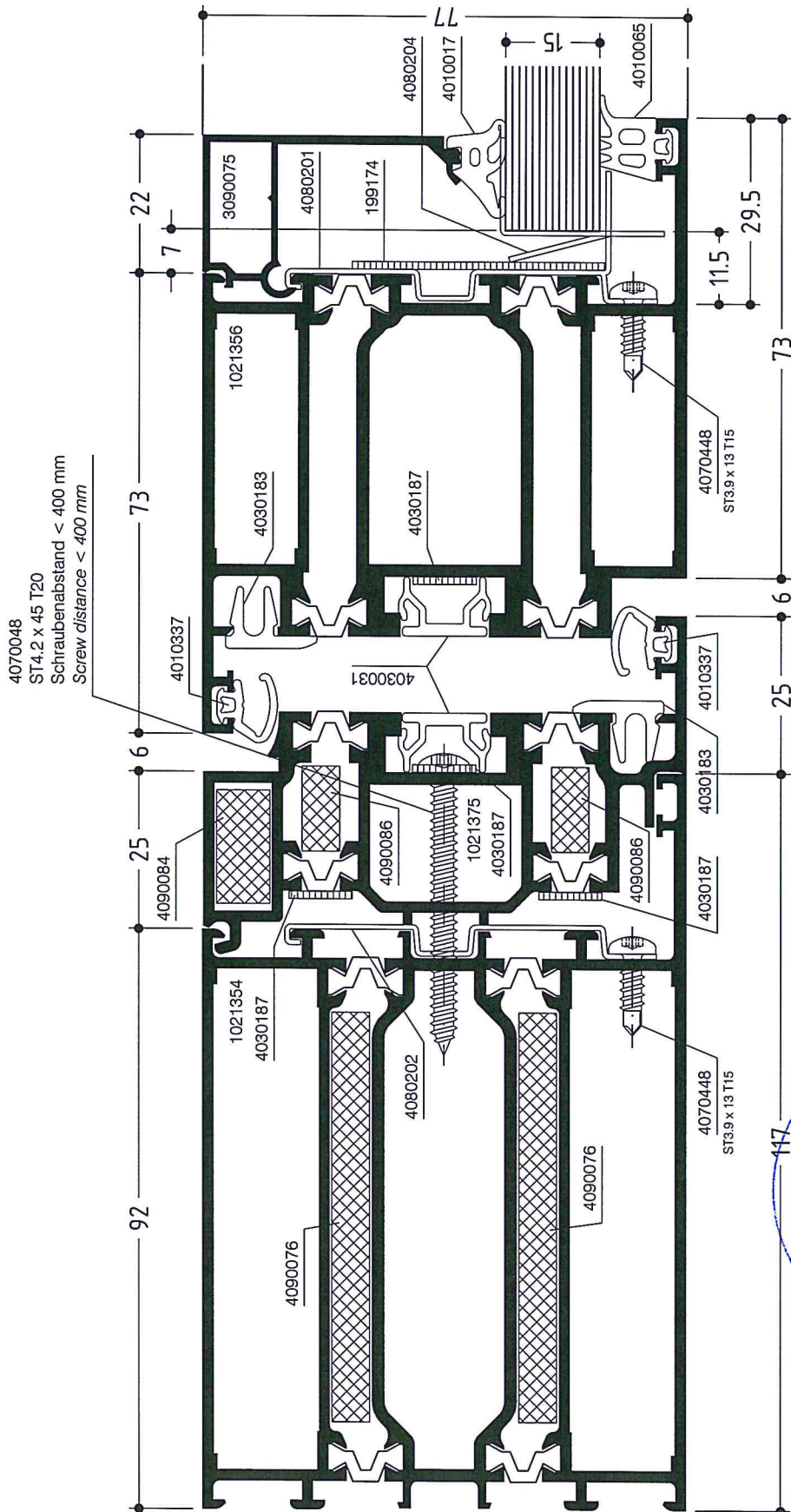

6. APR. 2017



WICSTYLE 77FP

Anschlagtüren einwärts mit Rahmenverbreiterung
 Hinged doors inwards with frame widening profile

Konstruktionsschnitt
 Construction section

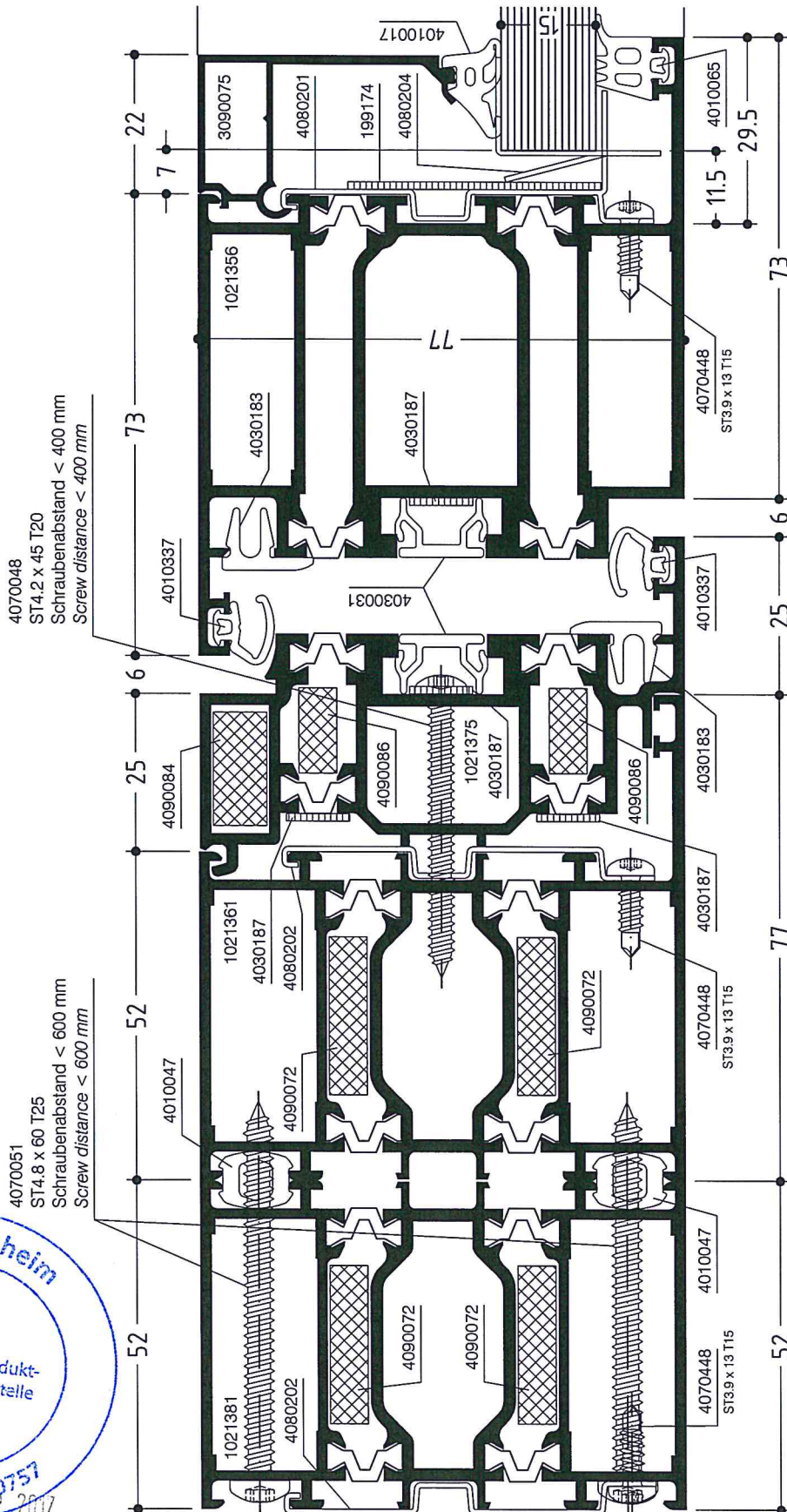
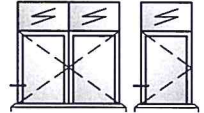

WICSTYLE 77FP

Anschlagtüren auswärts mit Stützenprofil nach außen verstärkt
 Hinged doors outwards with externally reinforced mullion profile

Konstruktionsschnitt Construction section

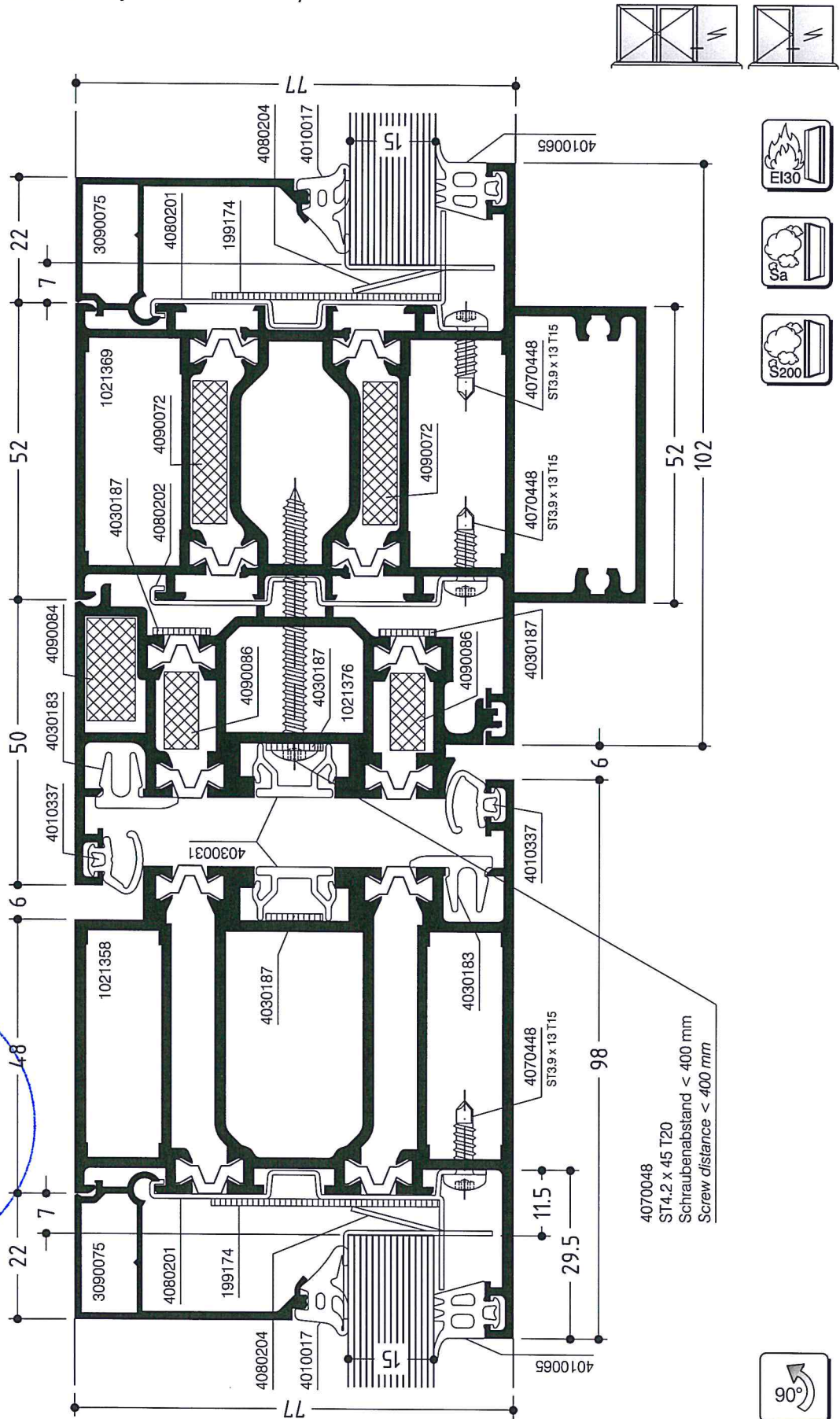

WICSTYLE 77FP

Anschlagtüren auswärts mit Seitenteil
 Hinged doors outwards with side part

Konstruktionsschnitt
 Construction section

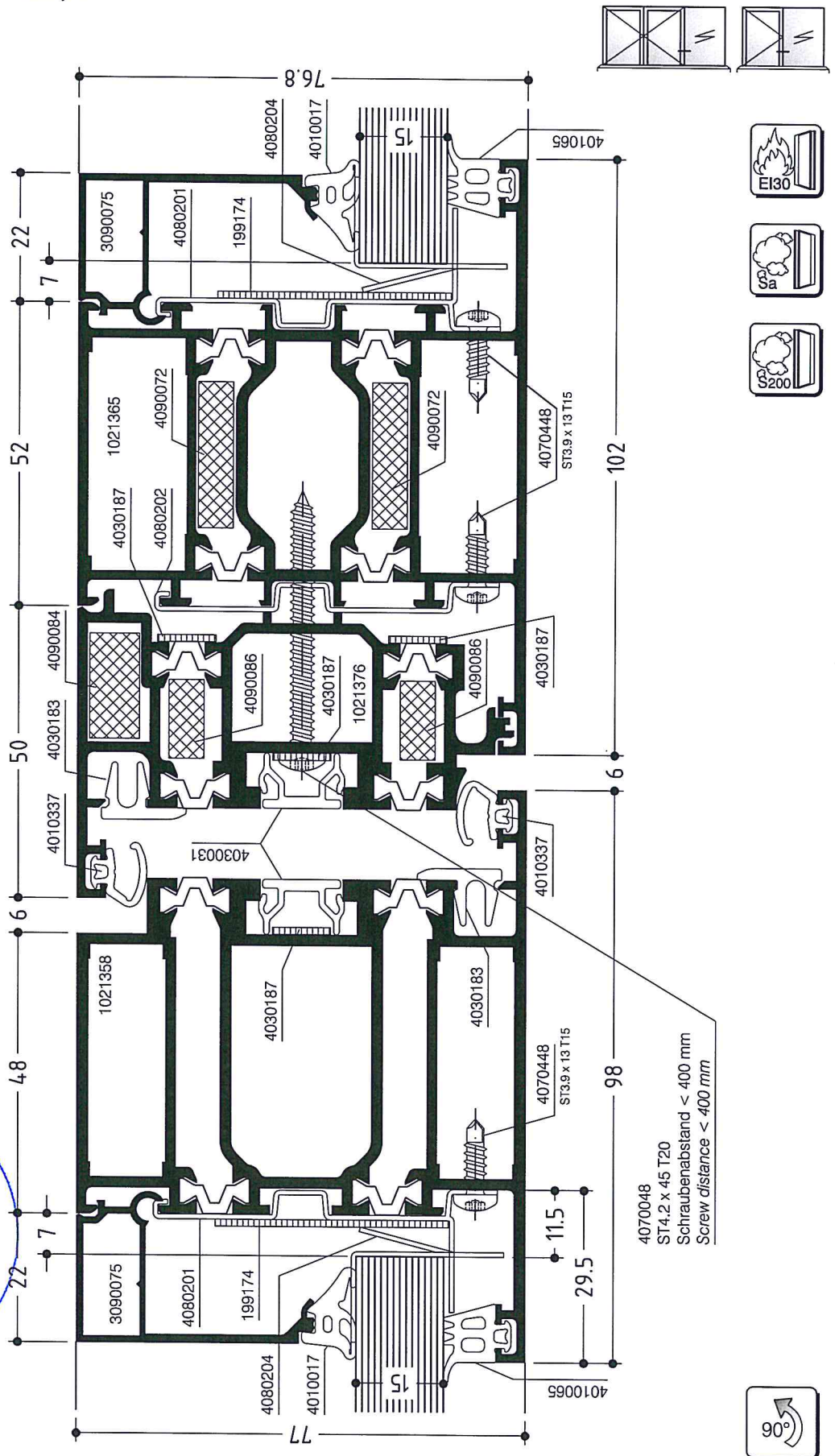

6. APR. 2017

WICSTYLE 77FP

Anschlagtüren einwärts mit Seitenteil
Hinged doors inwards with side part

Konstruktionsschnitt
Construction section

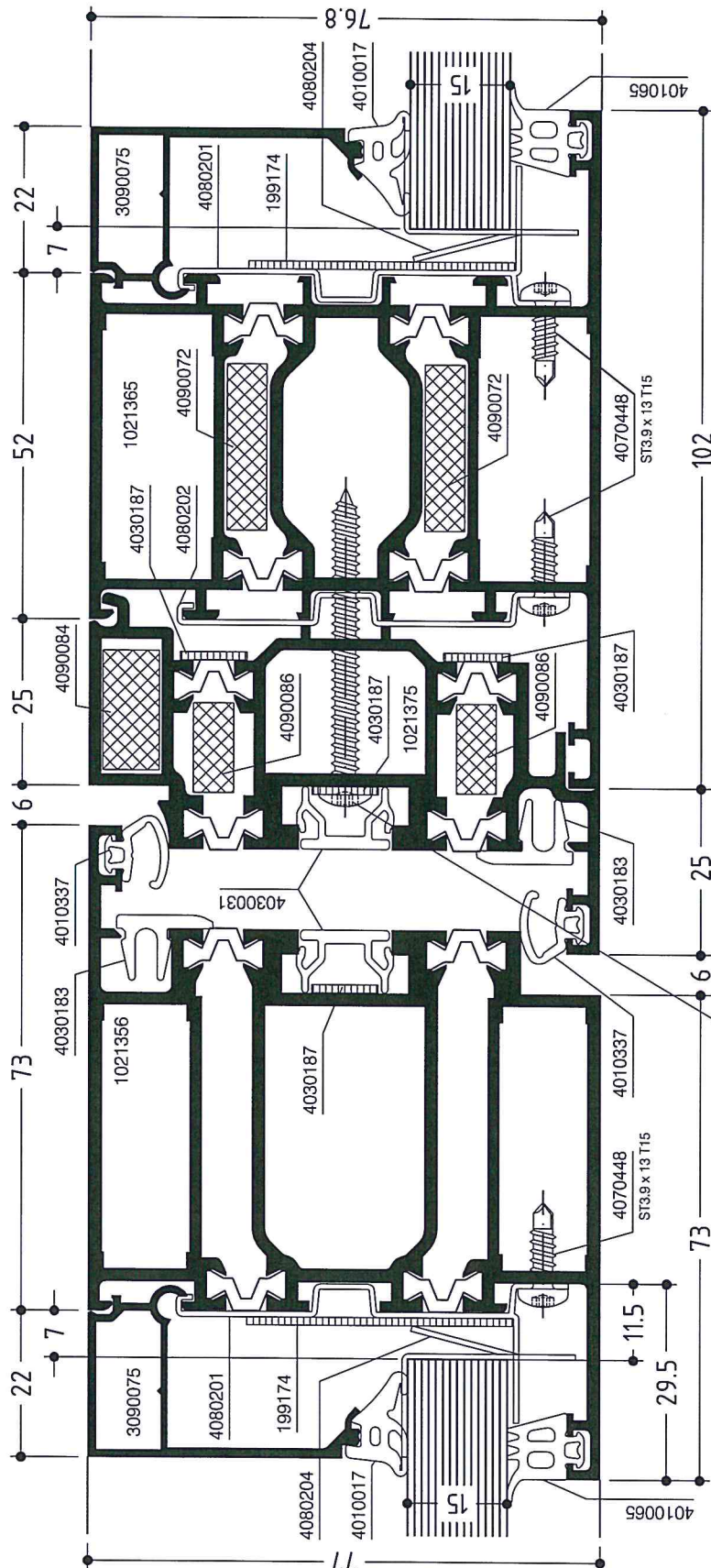
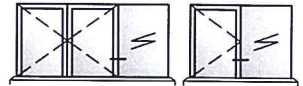

4070048
ST4.2 x 45 T20
Schraubenabstand < 400 mm
Screw distance < 400 mm



6. APR. 2017



WICSTYLE 77FP

Anschlagtüren einwärts
in Kombination mit Profil 1020450 oder 1020451
Hinged doors inwards
in combination with profile 1020450 or 1020451

Konstruktionsschnitt
Construction section

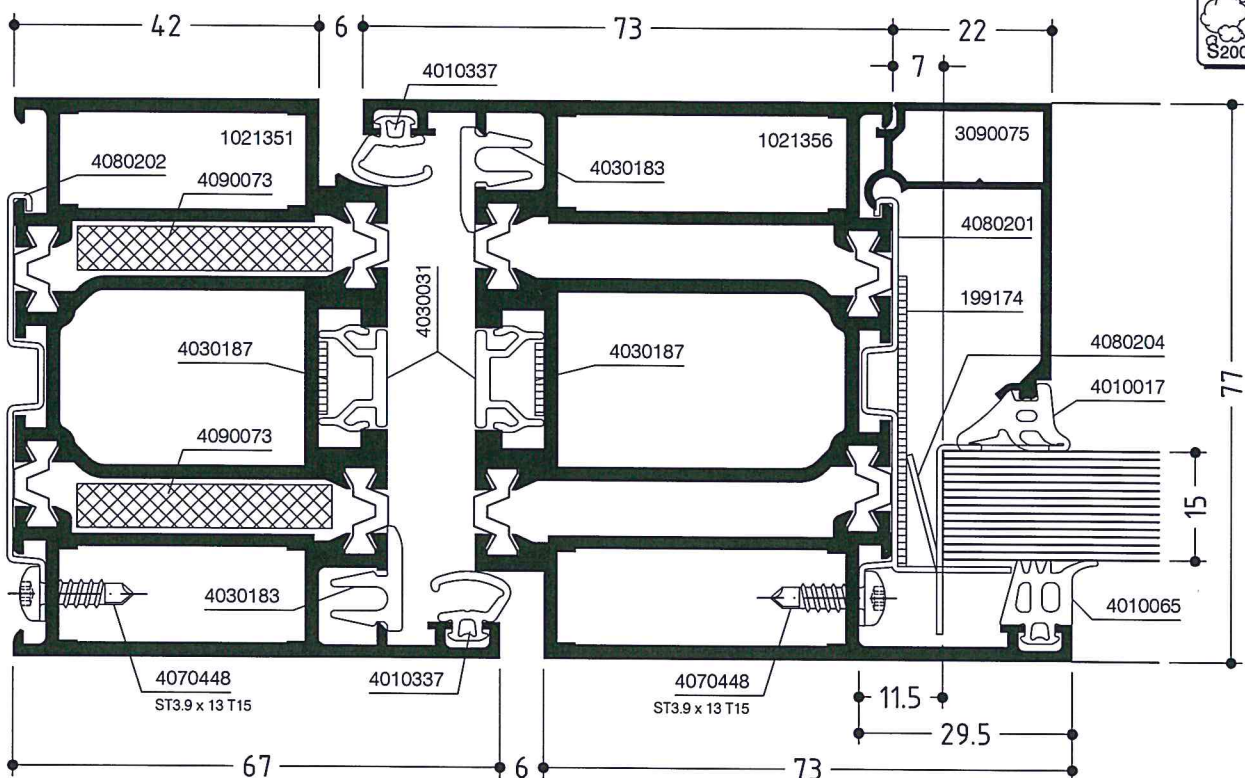
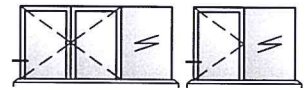

6. APR. 2017

WICSTYLE 77FP

Anschlagtüren einwärts mit Seitenteil und/oder Oberlicht
Hinged doors inwards with lateral part and/or fanlight

Technische Information *Technical Information*

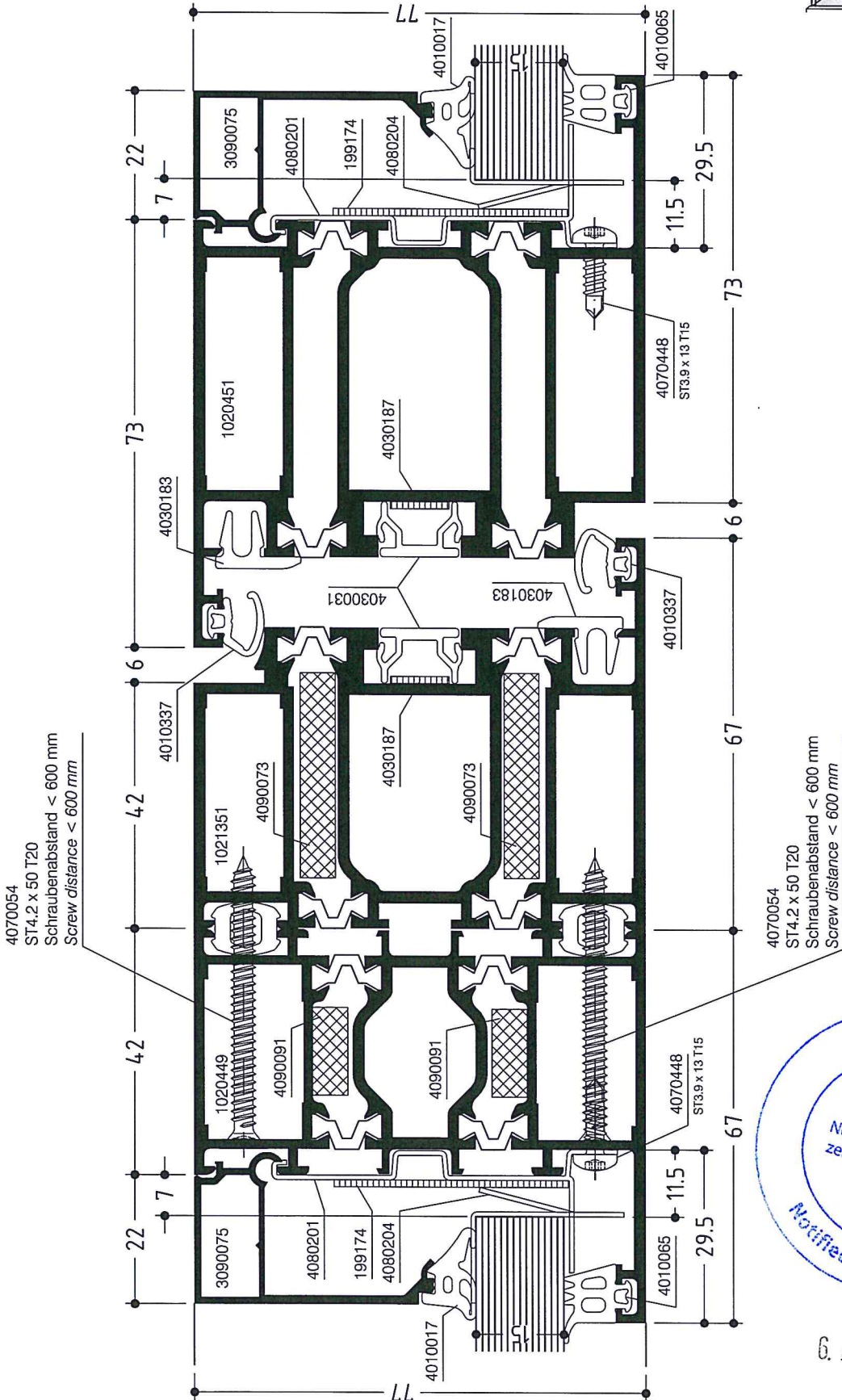
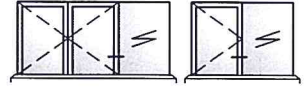

6. APR. 2017



WICSTYLE 77FP

Festverglasung, Seitenteil und/oder Oberlicht
Fixed glazing, lateral part and/or fanlight

Konstruktionsschnitt
Construction section

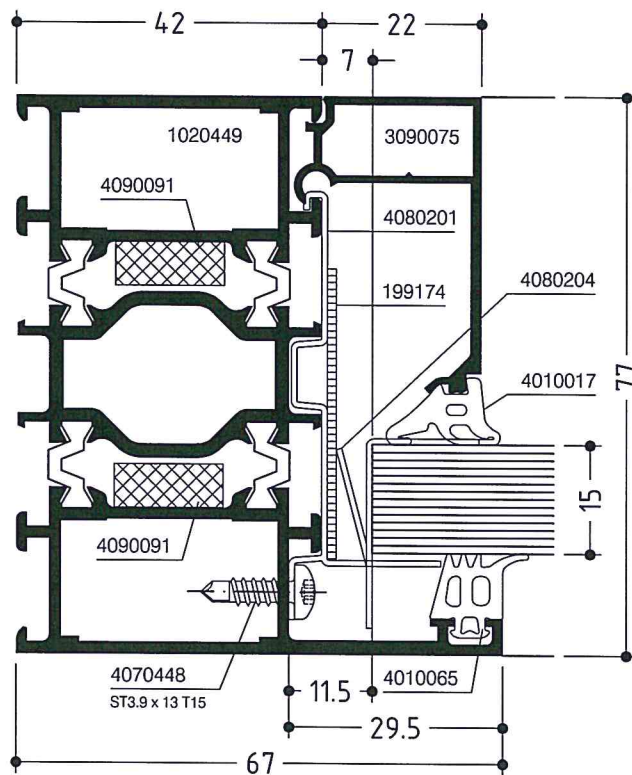
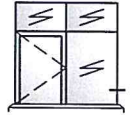

6. APR. 2017

WICSTYLE 77FP

Festverglasung, Seitenteil und/oder Oberlicht
Fixed glazing, lateral part and/or fanlight

Konstruktionsschnitt
Construction section

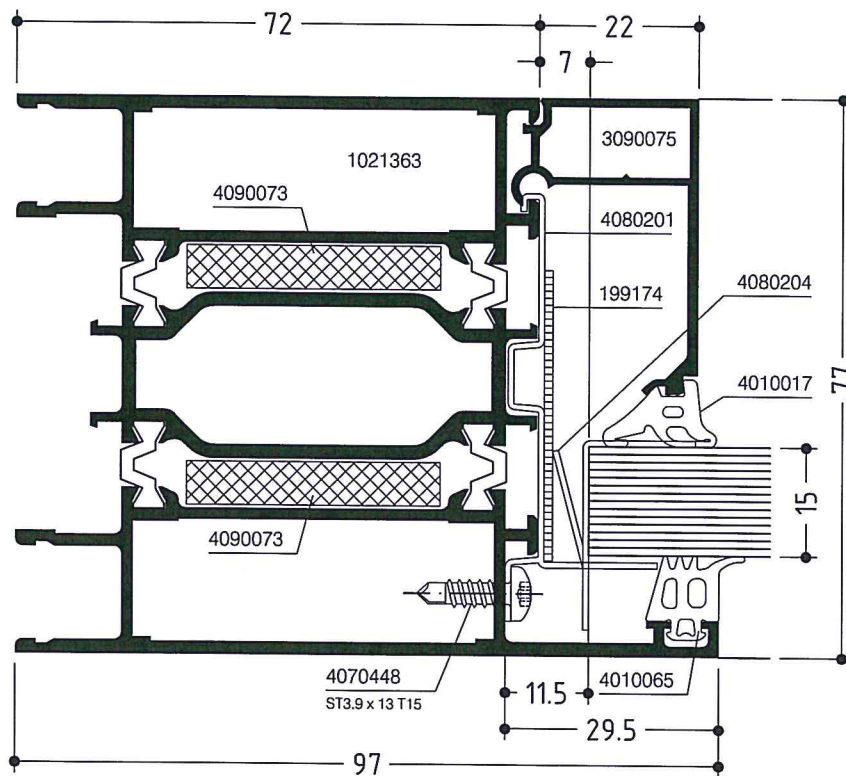
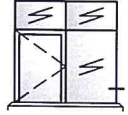

6. APR. 2017

WICSTYLE 77FP

Festverglasung, Seitenteil und/oder Oberlicht
 Fixed glazing, lateral part and/or fanlight

Konstruktionsschnitt
 Construction section

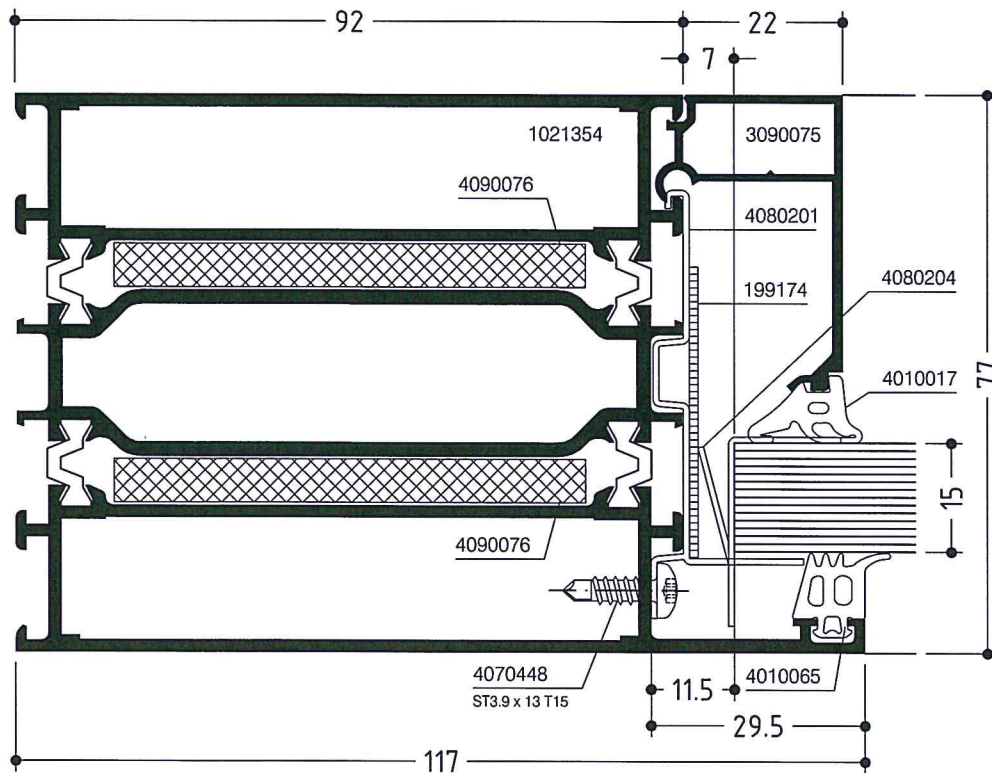
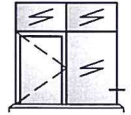

6. APR. 2017

WICSTYLE 77FP

Festverglasung mit Rahmenprofil und Rahmenverbreiterung
 Fixed glazing with frame profile and frame widening profile

Konstruktionsschnitt
 Construction section

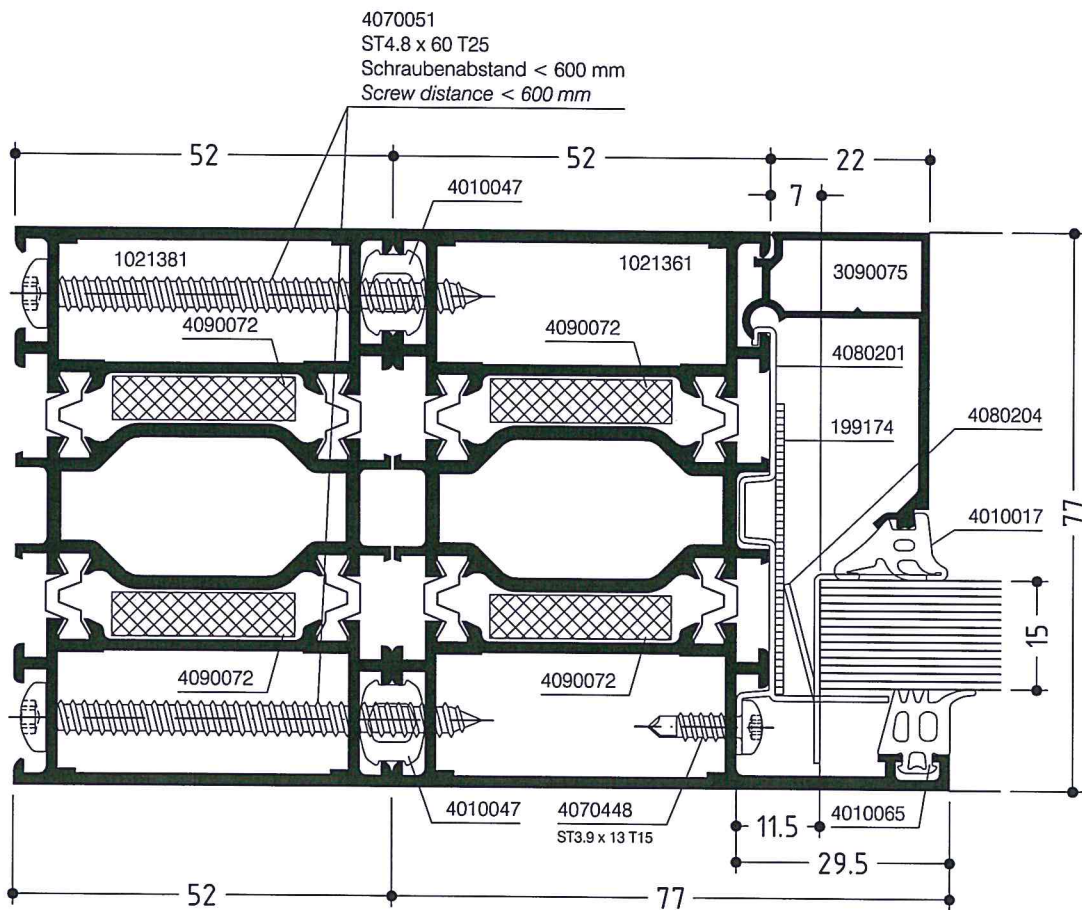
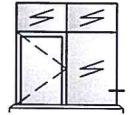

WICSTYLE 77FP

Festfeld, Seitenteil und/oder Oberlicht
Fixed field, lateral part and/or fanlight

Konstruktionsschnitt
Construction section

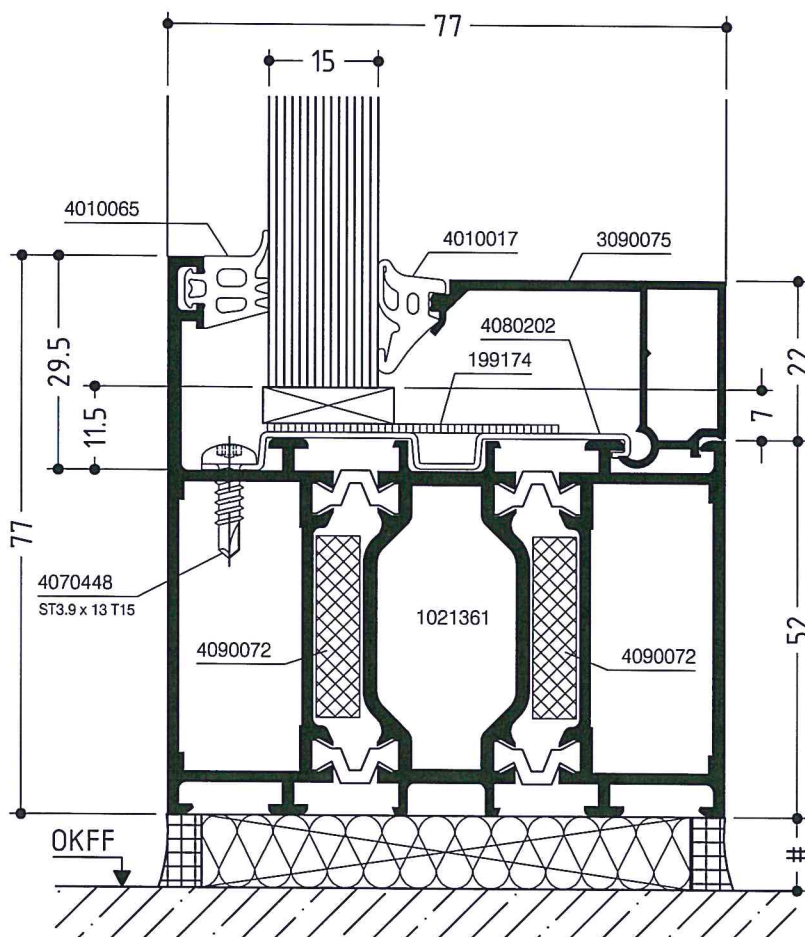
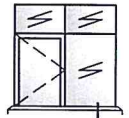

WICSTYLE 77FP

Festfeld mit Sockelprofil
Fixed field with bottom rail profile

Konstruktionsschnitt
Construction section

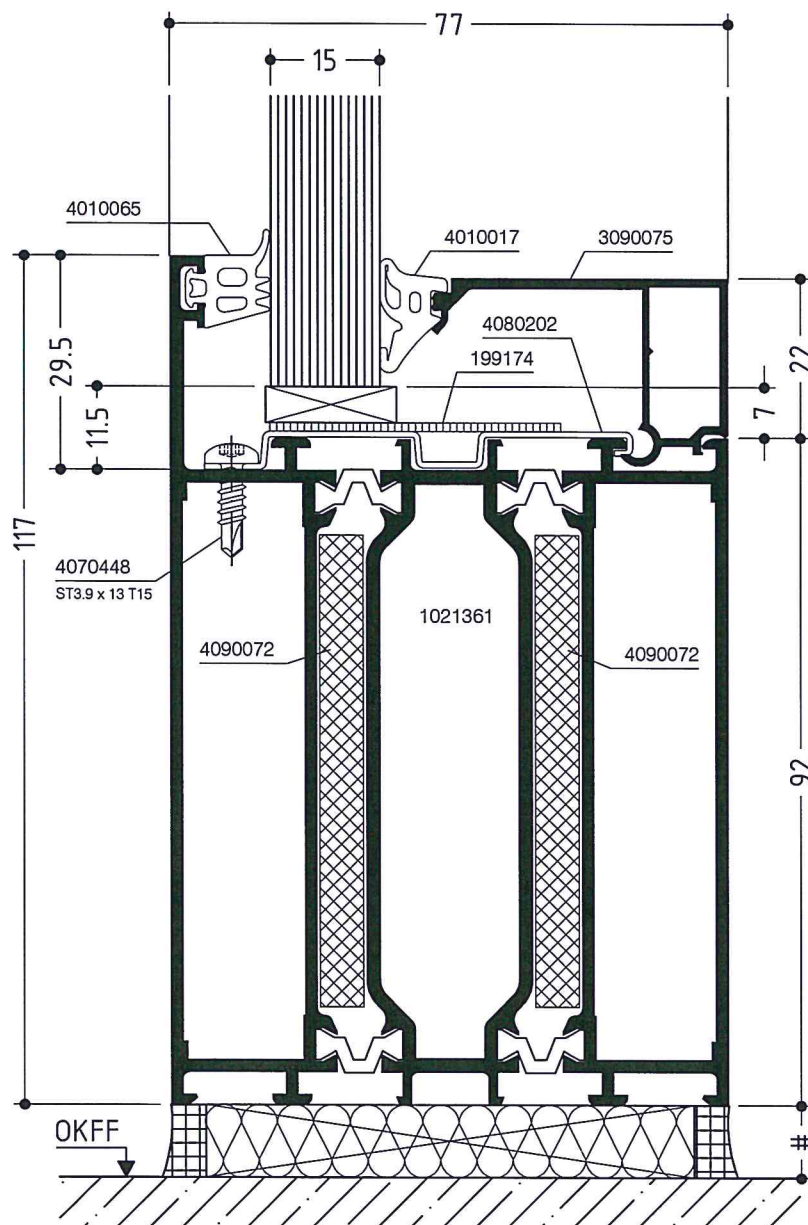
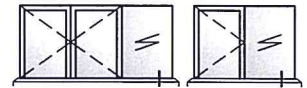

WICSTYLE 77FP

Festfeld mit Sockelprofil
Fixed field with bottom rail profile

Konstruktionsschnitt
Construction section

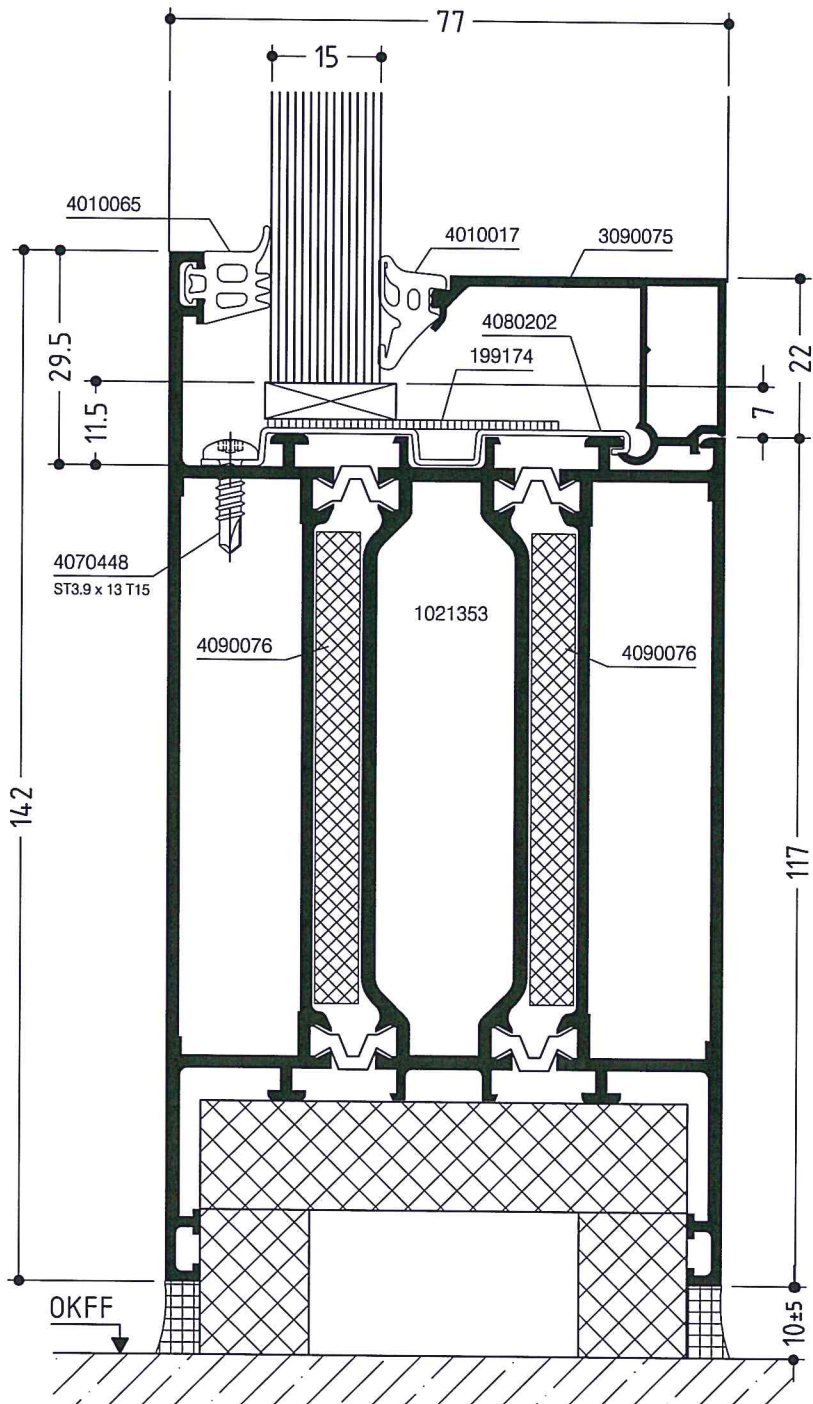
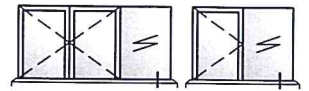

6. APR. 2017

WICSTYLE 77FP

Festfeld mit Sockelprofil
Fixed field with bottom rail profile

Konstruktionsschnitt
Construction section

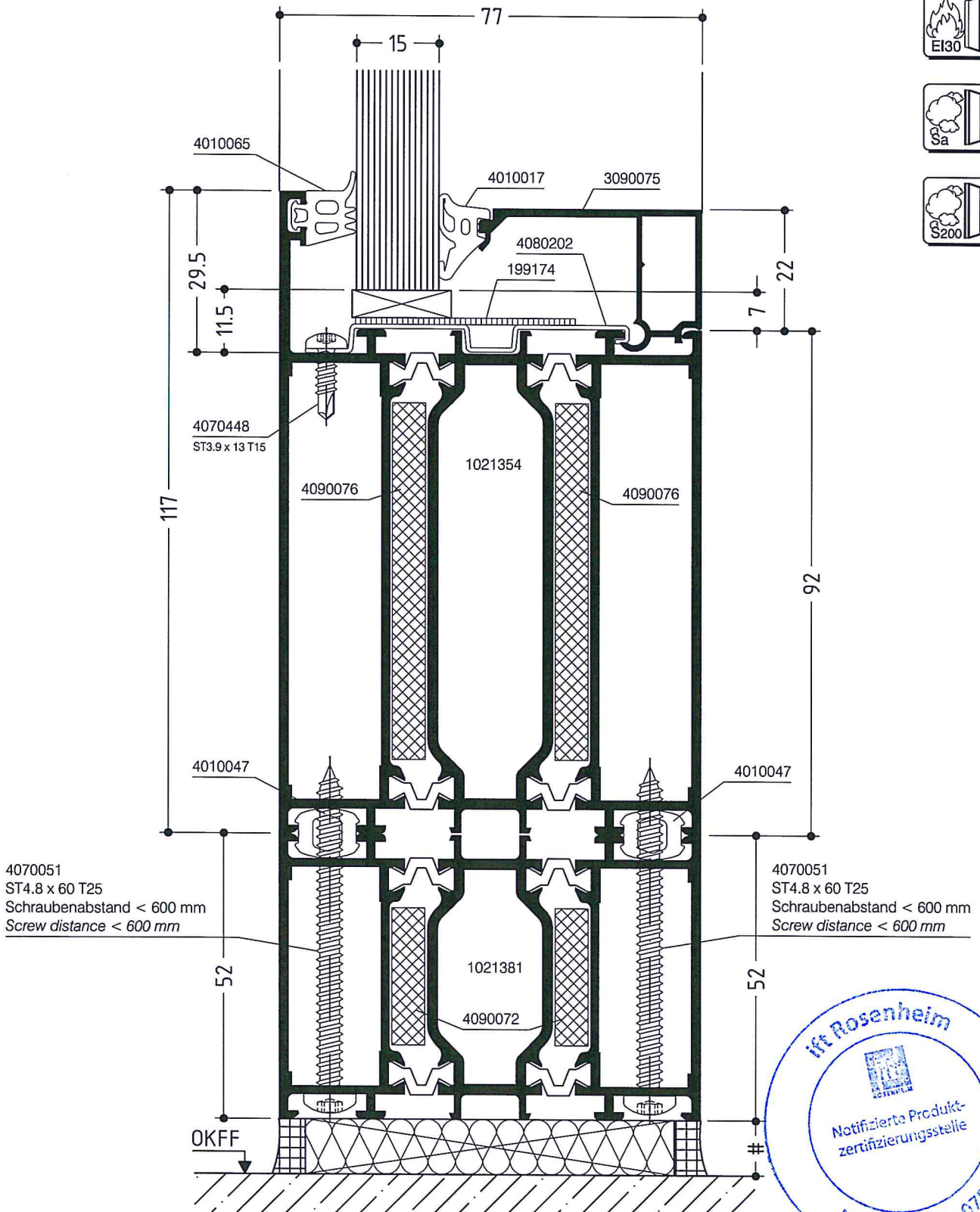
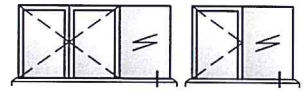

WICSTYLE 77FP

Festfeld mit Sockelprofil
Fixed field with bottom rail profile

Konstruktionsschnitt
Construction section

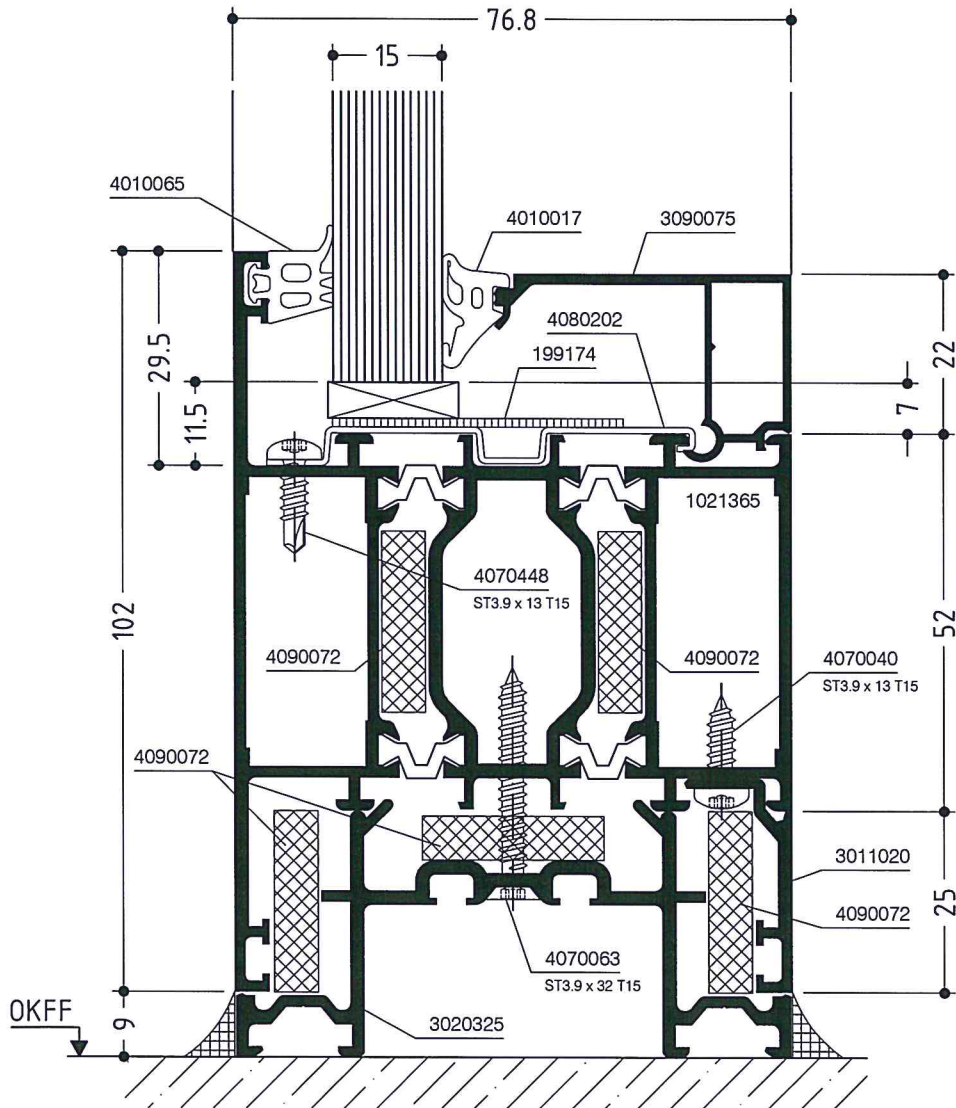
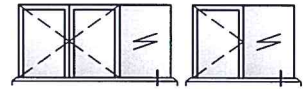

18. AUG. 2017

WICSTYLE 77FP

Sprossen im Türflügel
Glazing bars in door leaf

Konstruktionsschnitt
Construction section

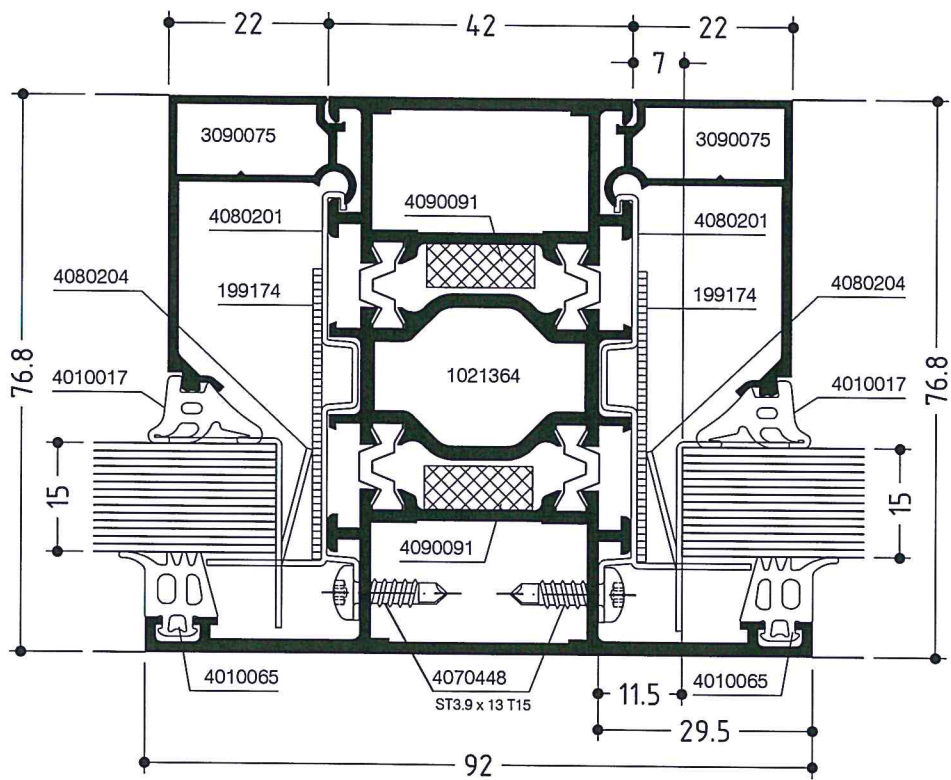
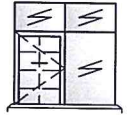

6. APR. 2017

WICSTYLE 77FP

Sprossen im Türflügel
Glazing bars in door leaf

Konstruktionsschnitt
Construction section

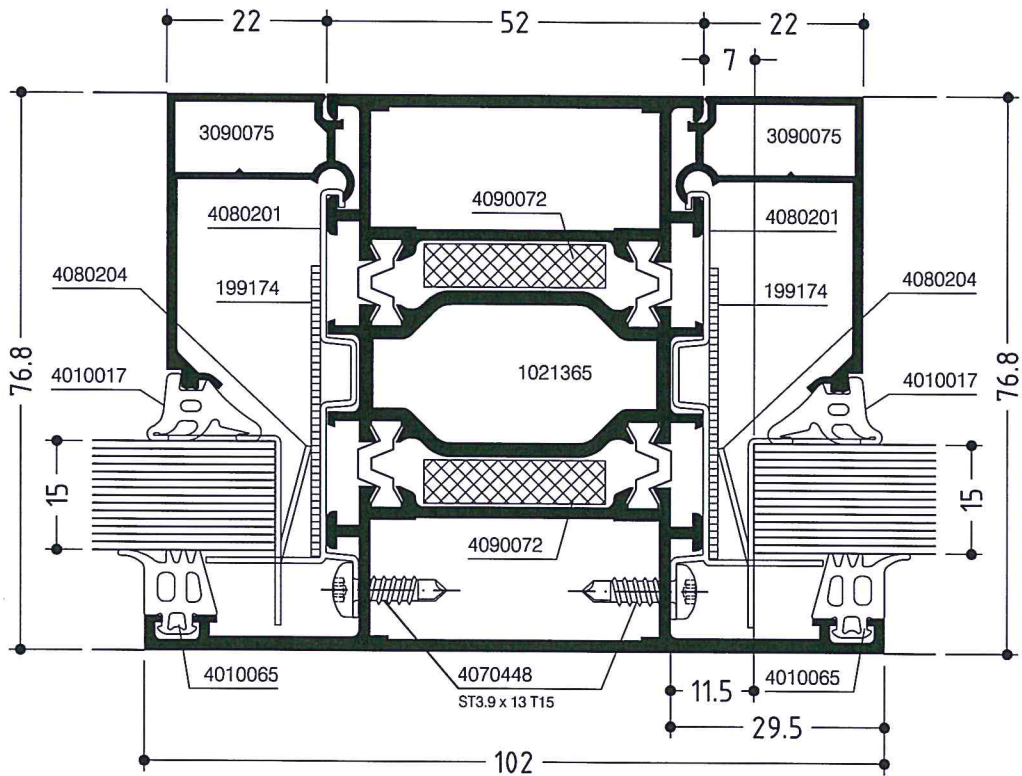
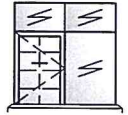

6. APR. 2017

WICSTYLE 77FP

Festverglasung mit Kämpferprofil und Türsprosse, Seitenteil
 Fixed glazing with transom profile and glazing bar, lateral part

Konstruktionsschnitt
 Construction section

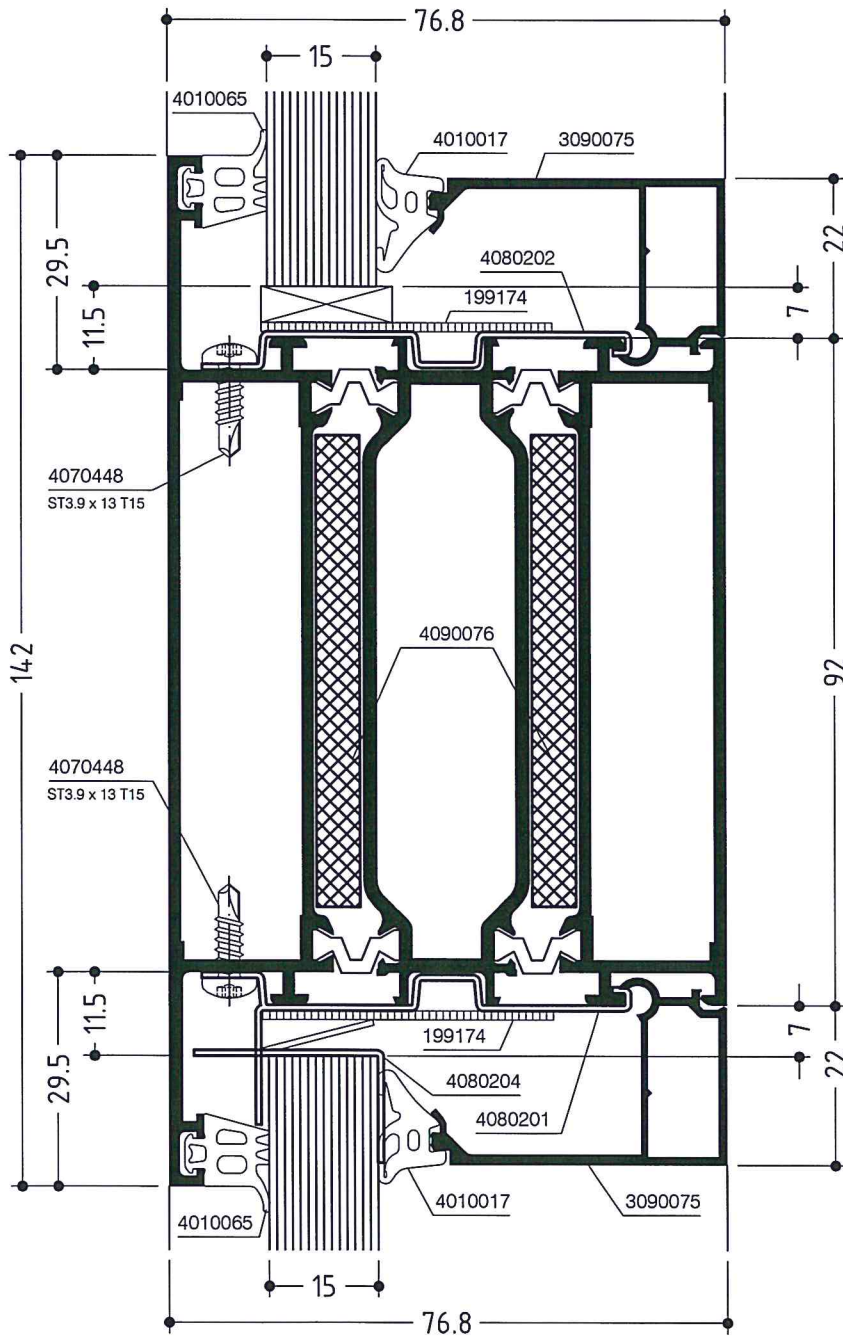
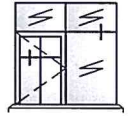

18. AUG. 2017

WICSTYLE 77FP

Konstruktionsschnitt

Construction section

Festverglasung mit Stützenprofil nach aussen verstärkt

Fixed glazing with externally reinforced mullion profile

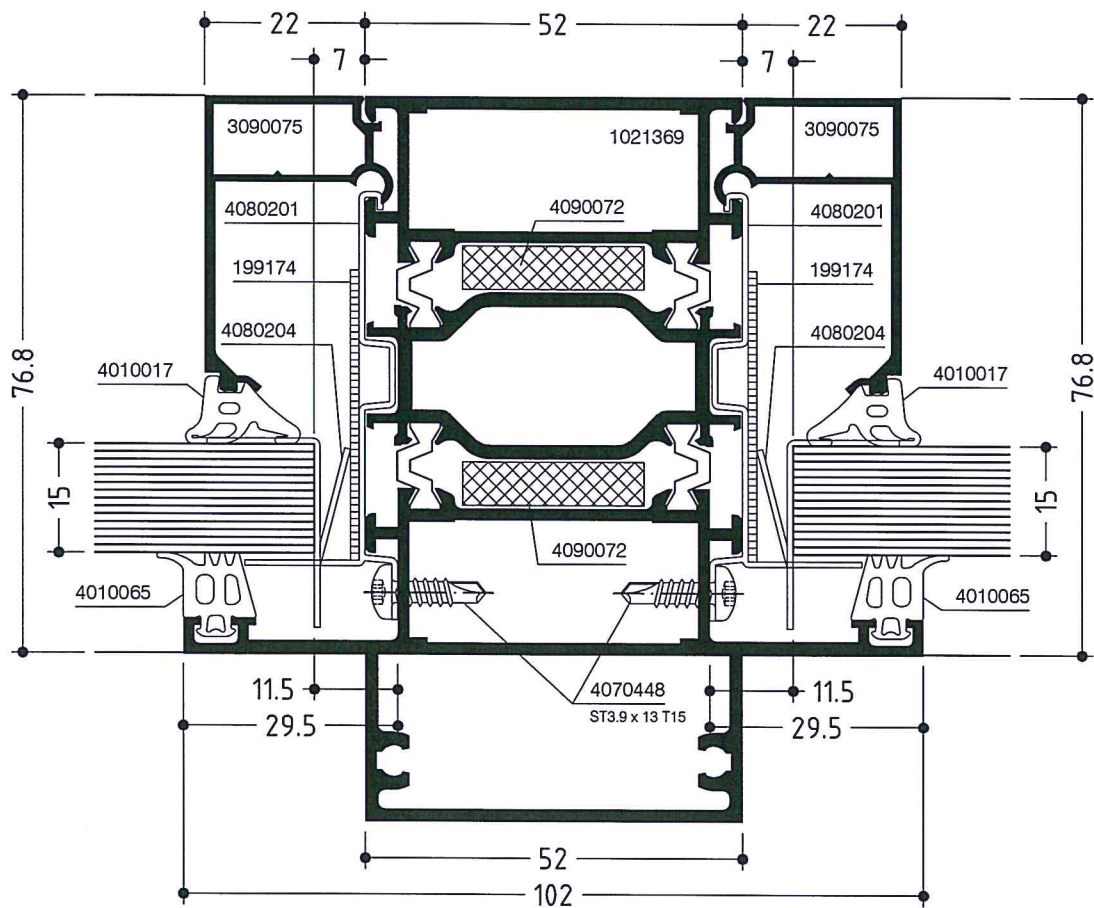
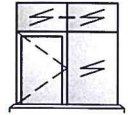

6. APR. 2017

WICSTYLE 77FP

Festverglasung mit Kämpferprofil und Verstärkungsprofil
 Fixed glazing with transom profile and reinforcement profile

Konstruktionsschnitt
 Construction section

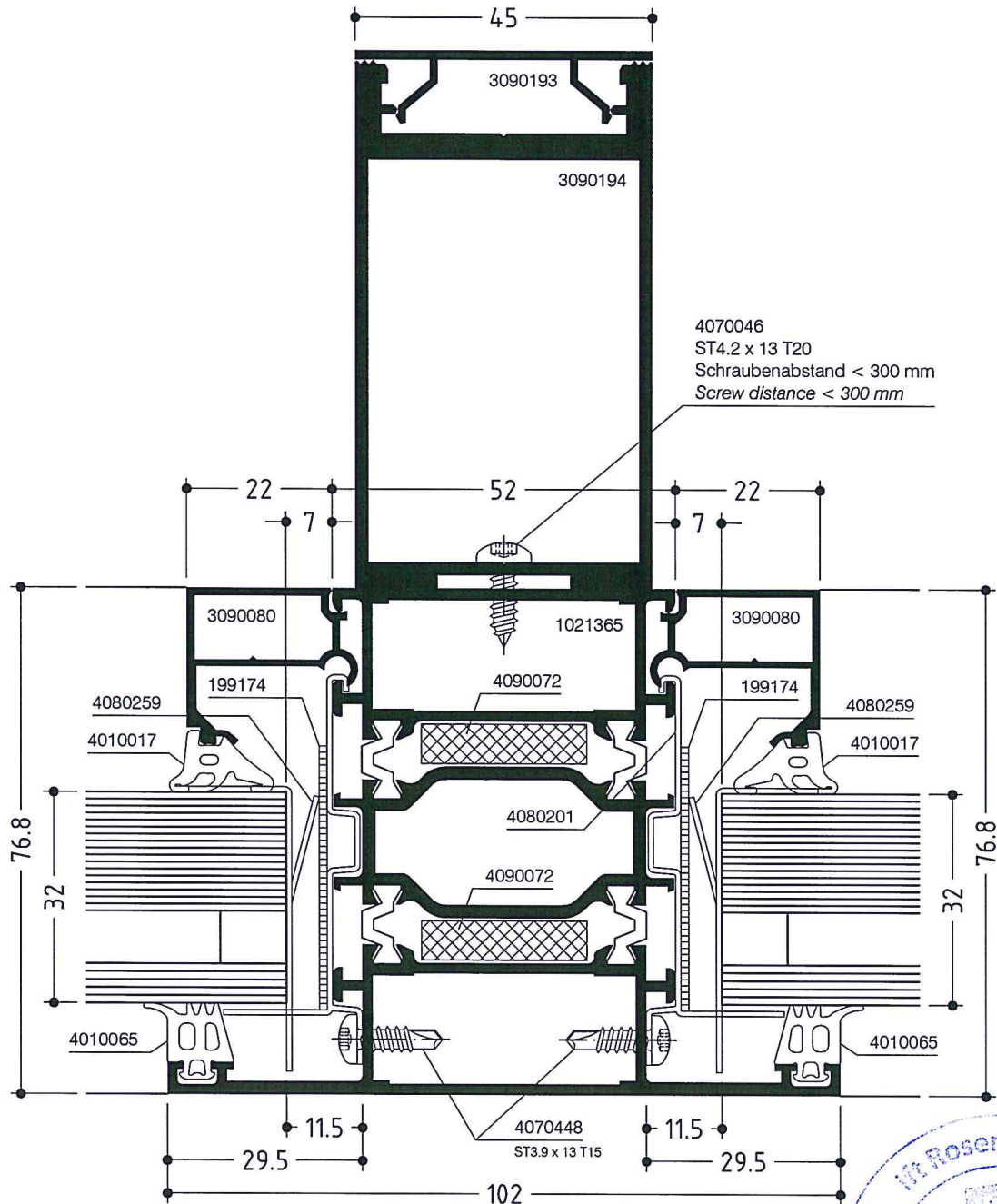
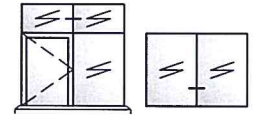

18. AUG. 2017

WICSTYLE 77FP

Anschlagtüren auswärts kombiniert mit WICTEC 50FP
 Hinged doors outwards combined with WICTEC 50FP

Konstruktionsschnitt
 Construction section

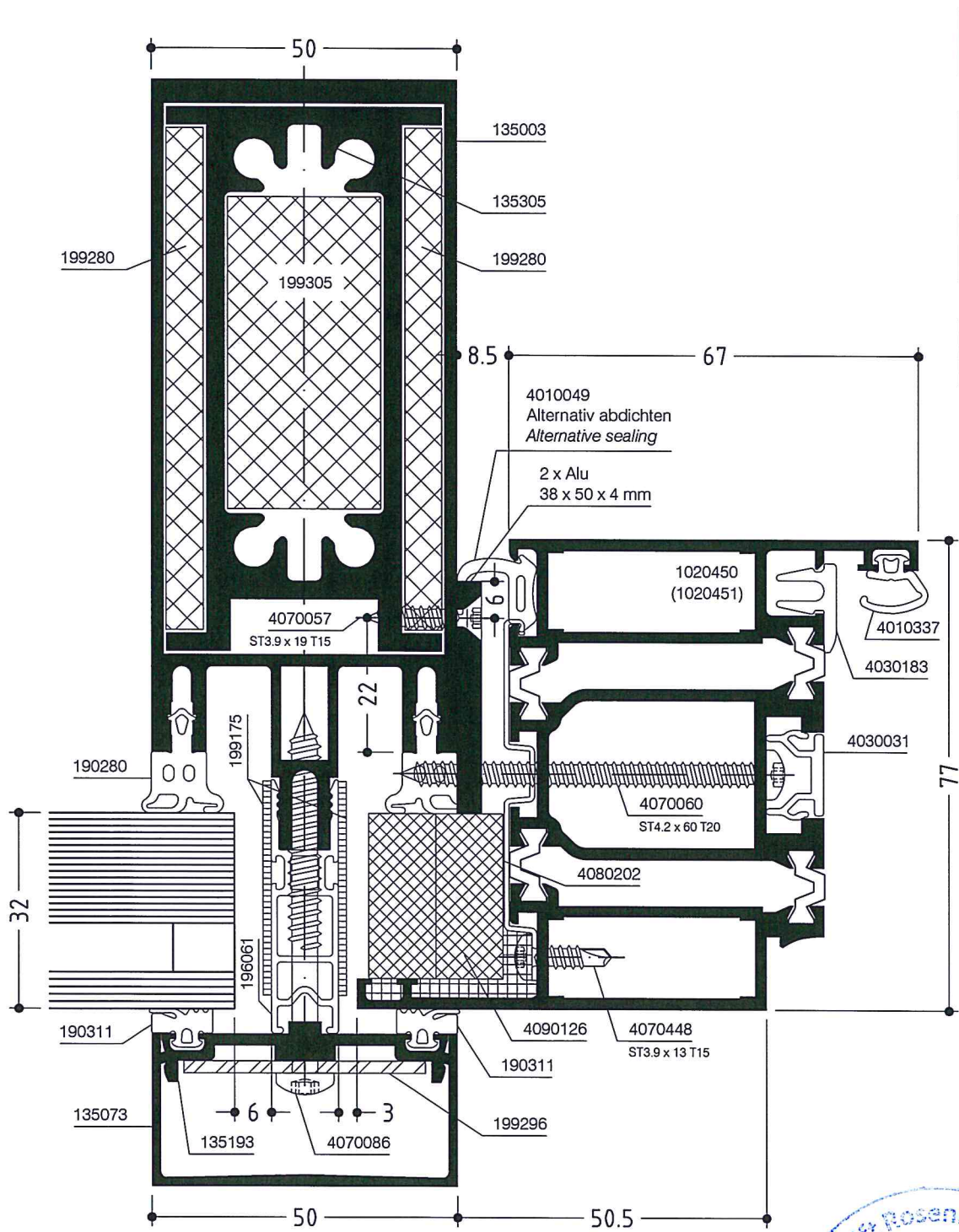
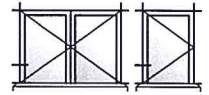

WICSTYLE 77FP

Anschlagtüren auswärts kombiniert mit WICTEC 50FP
 Hinged doors outwards combined with WICTEC 50FP

Konstruktionsschnitt
 Construction section

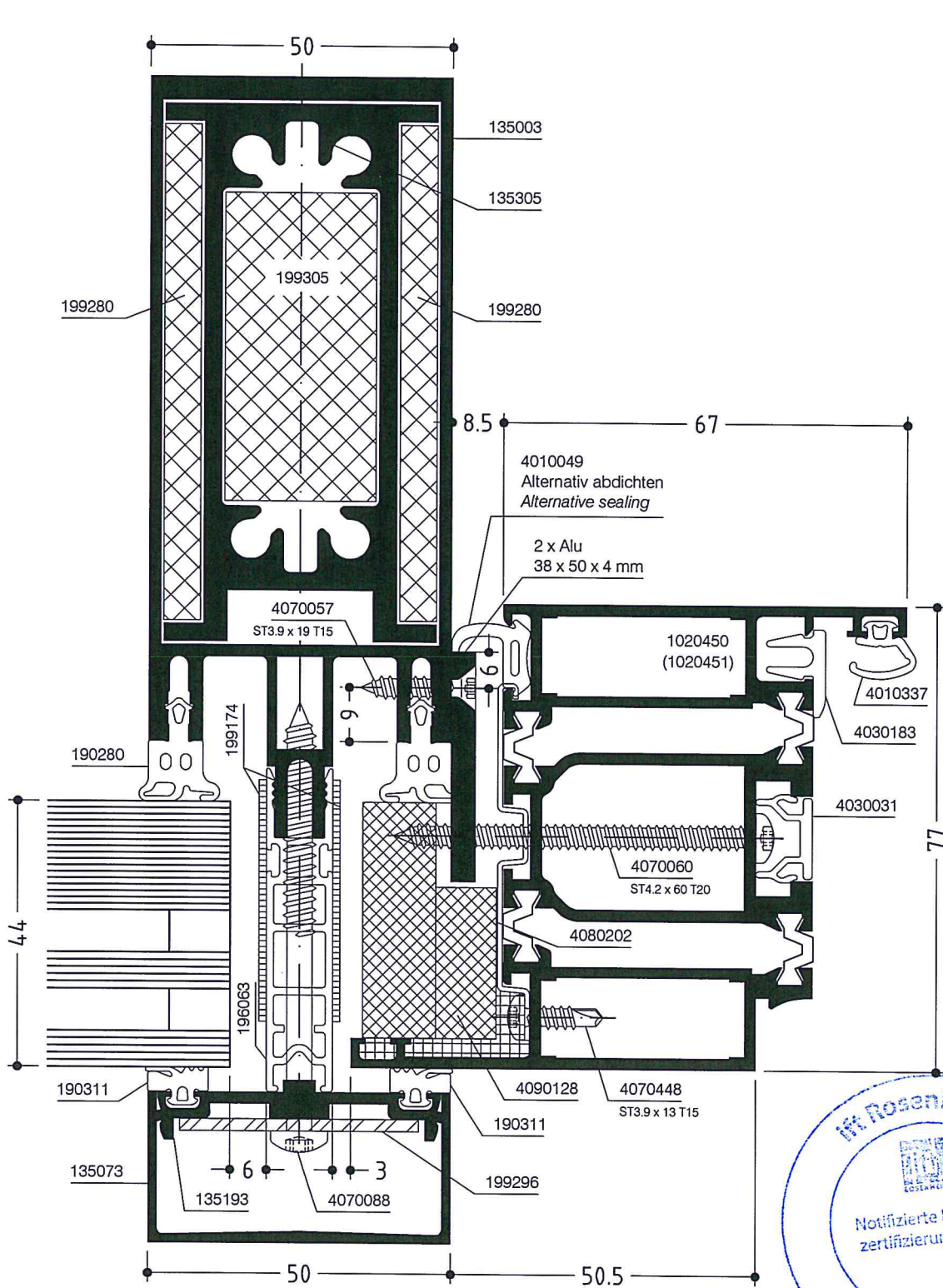
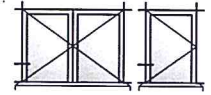

WICSTYLE 77FP

Anschlagtüren auswärts kombiniert mit WICTEC 50FP
 Hinged doors outwards combined with WICTEC 50FP

Konstruktionsschnitt
 Construction section

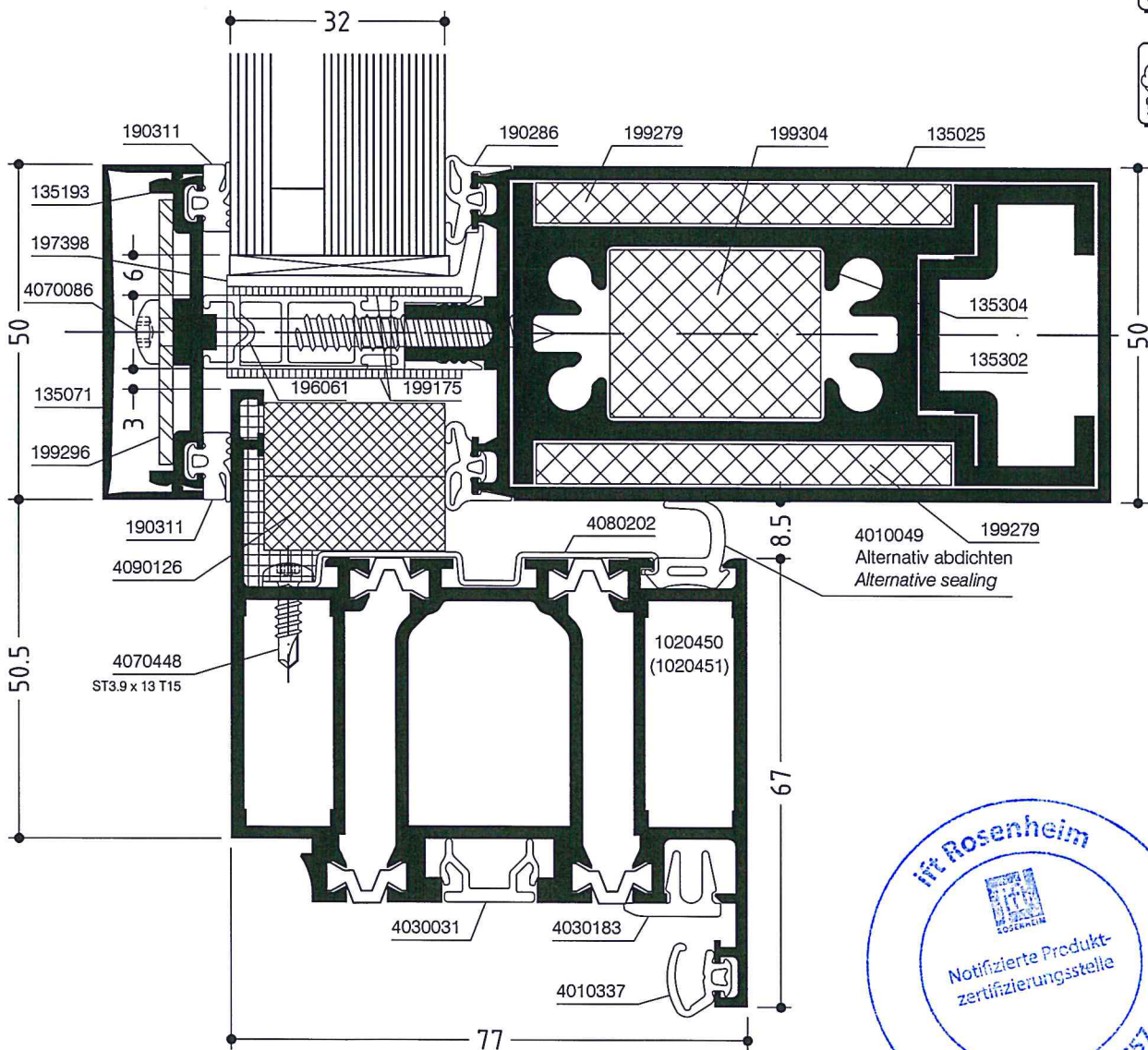
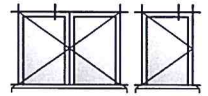

6. APR. 2017

WICSTYLE 77FP

Anschlagtüren auswärts kombiniert mit WICTEC 50FP
 Hinged doors outwards combined with WICTEC 50FP

Konstruktionsschnitt
 Construction section

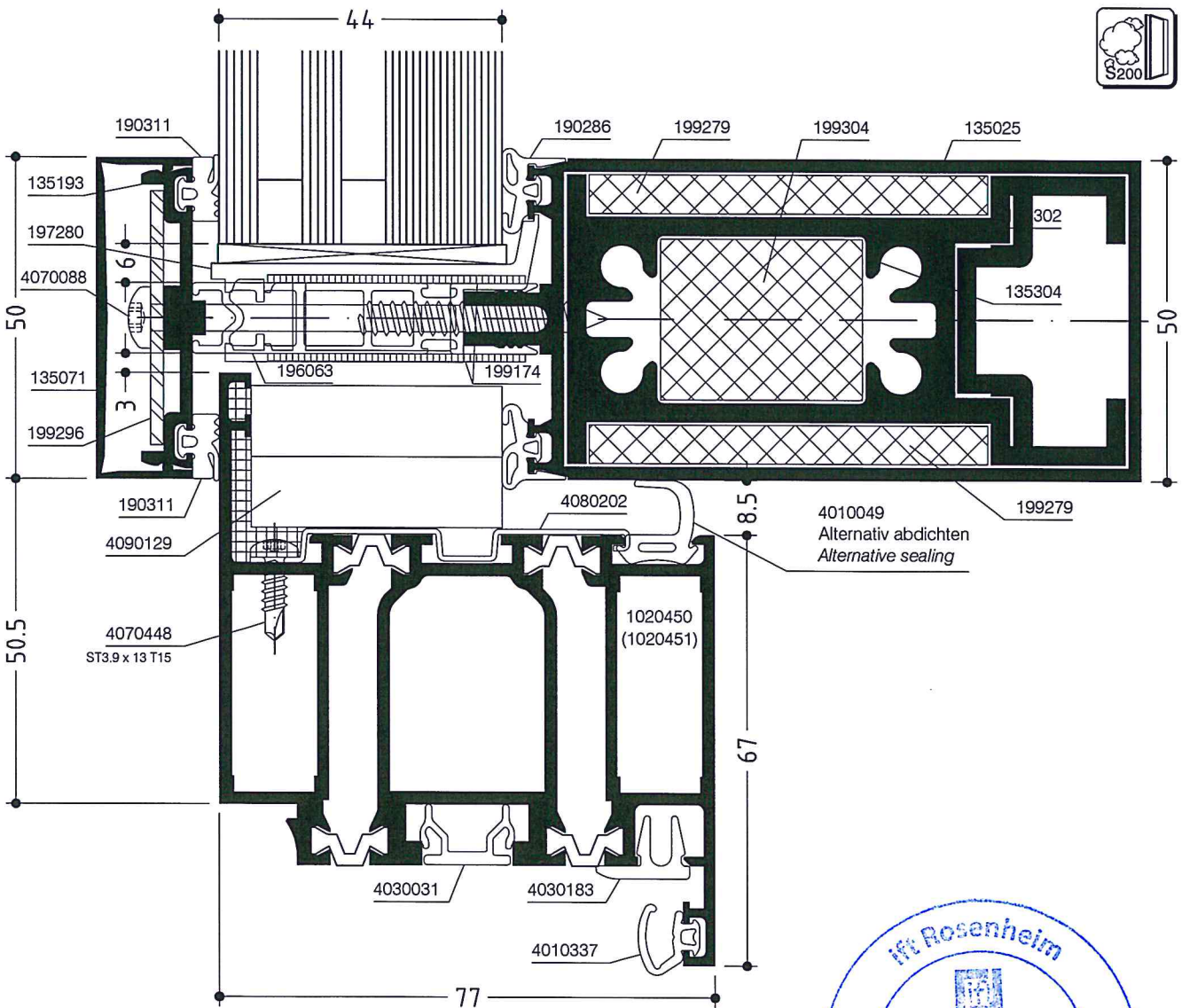
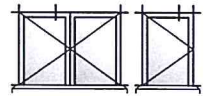

WICSTYLE 77FP

Auswahltabellen
Selection tables

Technische Information
Technical Information

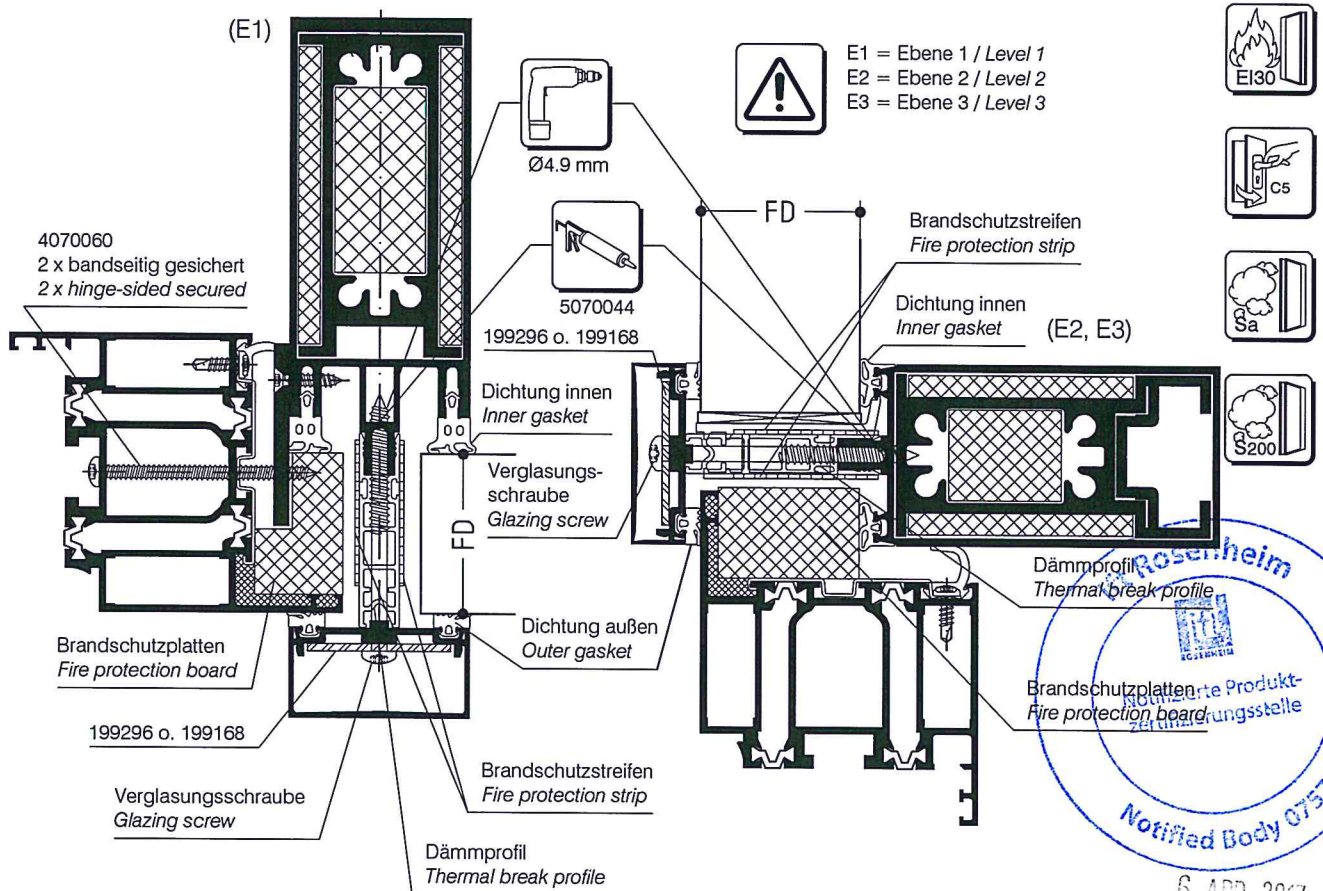
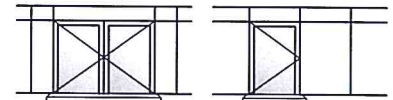

E1 = Ebene 1 / Level 1
E2 = Ebene 2 / Level 2
E3 = Ebene 3 / Level 3



Füllungsdicke (FD) einschließlich Dicken- toleranz (mm) Infill thickness (IT) including thickness tolerance (mm)	Dichtung innen Inner gasket		Dämmprofil (Bauhöhe in mm) Thermal break profile (construction height in mm)	Dichtung außen Outer gasket	Verglasungsschraube ST5.5 T25. Linsen- blechschr. (Länge) Zylinderblechschr. (Länge) Glazing screw ST5.5 T25. Fillister socket head screw (length)	Vorklotz (Prof. Nr.) Vorklotz verstärkt Shim (profile no.) Reinforced shim	Brand- schutz- streifen Fire protection strip	Brand- schutz- platten Fire protection board
	Pfosten E1 Mullion E1 (Spalt / Gap)	Riegel E2, E3 Transom E2, E3 (Spalt / Gap)						
15 - 17 17 - 19 19 - 21	190281 (12) 190280 (10)	190288 (8) 190287 (6) 190286 (4)	196059 (18)	190312 (4) 190311 (4)	4070084 (47) 4070093 (47)	197400	199176	4090124
21 - 23 23 - 25 25 - 27	190282 (14) 190281 (12) 190280 (10)	190288 (8) 190287 (6) 190286 (4)	196060 (24)	190312 (4) 190311 (4)	4070085 (53) 4070094 (53)	197399	199175	4090125
27 - 29 29 - 31 31 - 33	190282 (14) 190281 (12) 190280 (10)	190288 (8) 190287 (6) 190286 (4)	196061 (30)	190312 (4) 190311 (4)	4070086 (59) 4070095 (59)	197398	199175	4090126
33 - 35 35 - 37 37 - 39	190282 (14) 190281 (12) 190280 (10)	190288 (8) 190287 (6) 190286 (4)	196062 (36)	190312 (4) 190311 (4)	4070087 (65) 4070096 (65)	197279	199174	4090127
39 - 41 41 - 43 43 - 45	190282 (14) 190281 (12) 190280 (10)	190288 (8) 190287 (6) 190286 (4)	196063 (42)	190312 (4) 190311 (4)	4070088 (71) 4070097 (71)	197280	199174	4090129 (4090128)
45 - 47 47 - 49 49 - 51	190282 (14) 190281 (12) 190280 (10)	190288 (8) 190287 (6) 190286 (4)	196064 (48)	190312 (4) 190311 (4)	4070028 (77) 4070513 (77)	4080376 E2 4080379 E3	199174	4090132 (4090131)

WICSTYLE 77FP

Konstruktionsschnitt
Construction section

Anschlagtüren einwärts mit Spezialblendrahmen und flächenbündiger Verglasung
Hinged doors inwards with special frame and flush glazing

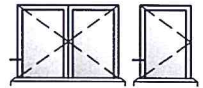

Variante 1
Variant 1

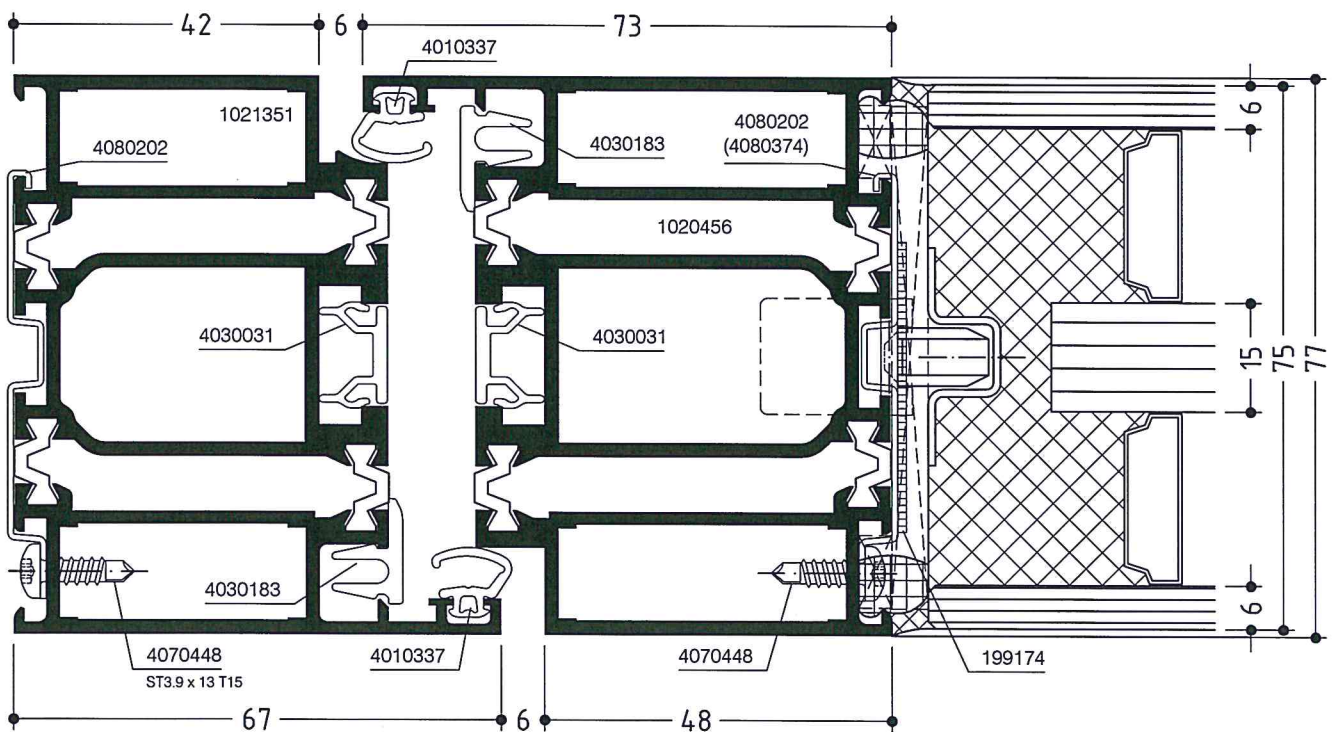

6. APR. 2017

WICSTYLE 77FP

Konstruktionsschnitt Construction section

Anschlagtüren einwärts mit Spezialblendrahmen und flächenbündiger Verglasung einseitig
Hinged doors inwards with special frame and flush glazing one-sided

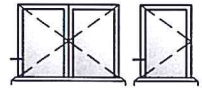

Variante 2
Variant 2

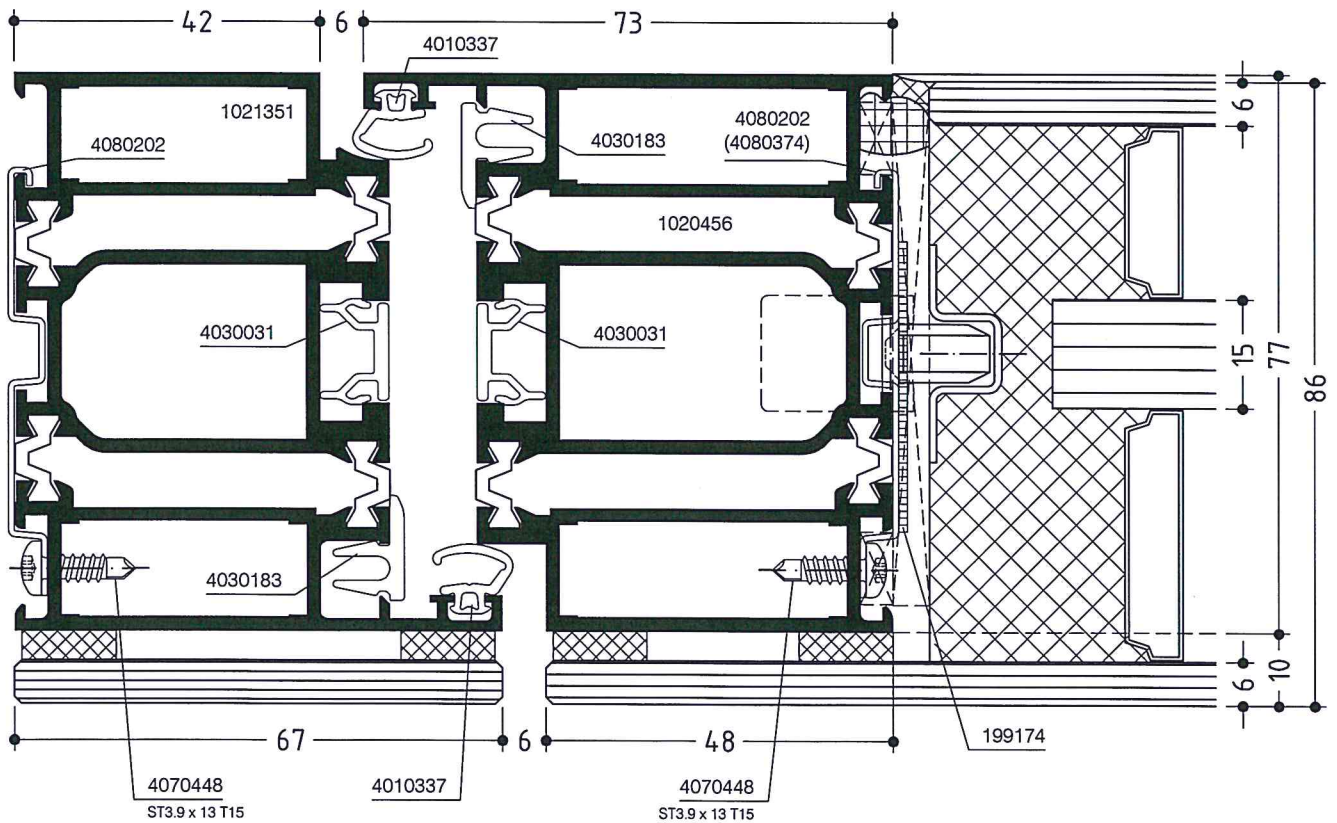

WICSTYLE 77FP

Konstruktionsschnitt Construction section

Anschlagtüren einwärts mit Spezialblendrahmen und flächenbündiger Verglasung beidseitig

Hinged doors inwards with special frame profile and flush glazing both sides

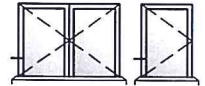

Variante 3

Variant 3

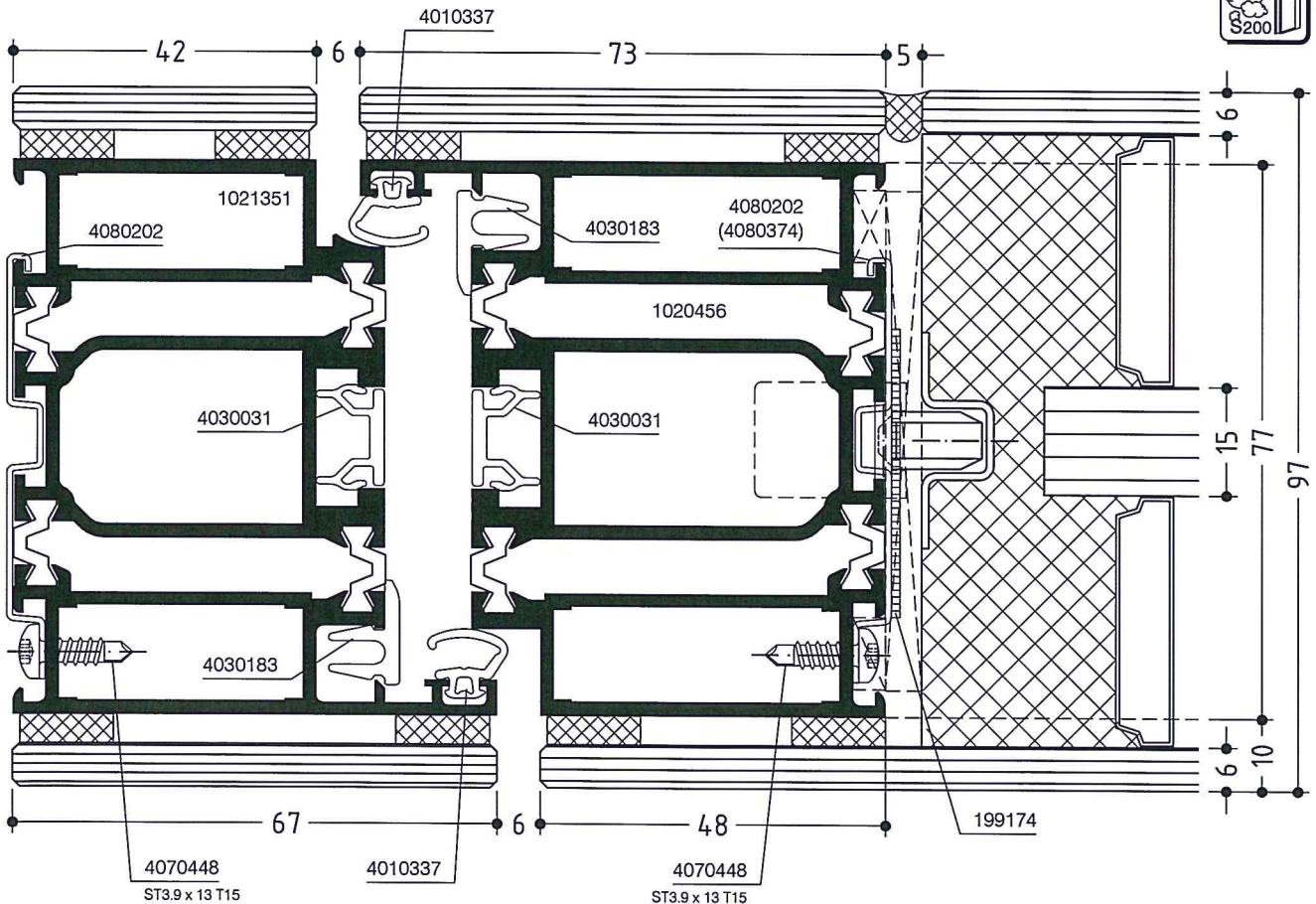

WICSTYLE 77FP

Anschlagtüren einwärts mit Rahmenverbreiterung
und flächenbündiger Verglasung
*Hinged doors inwards with frame widening profile
and flush glazing*

Konstruktionsschnitt
Construction section

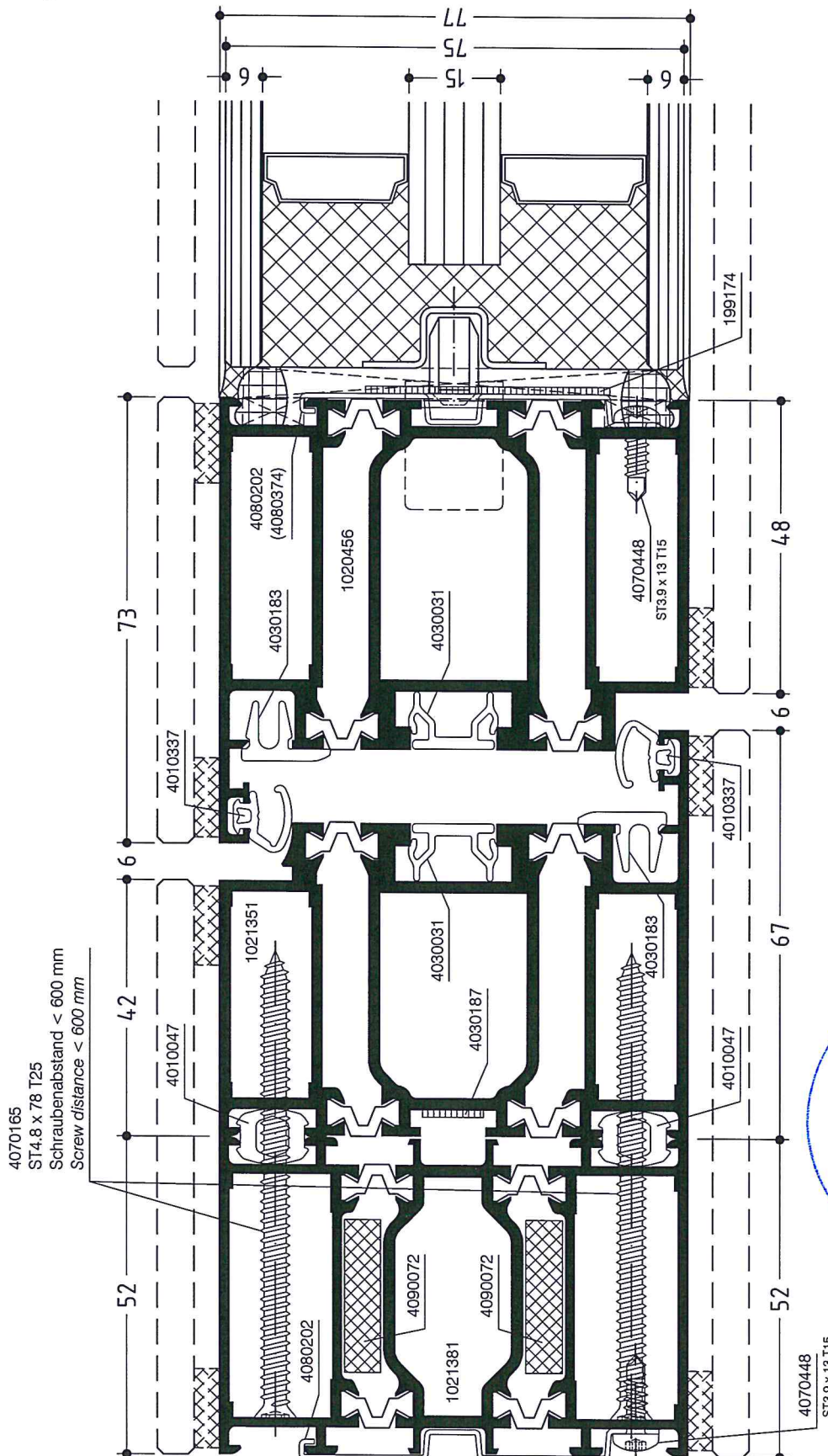
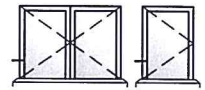

6. APR. 2017



WICSTYLE 77FP

Konstruktionsschnitt

Construction section

Anschlagtüren einwärts / auswärts mit Flügelprofil umlaufend
und flächenbündiger Verglasung

Hinged doors inwards / outwards with circumferential leaf profile
and flush glazing

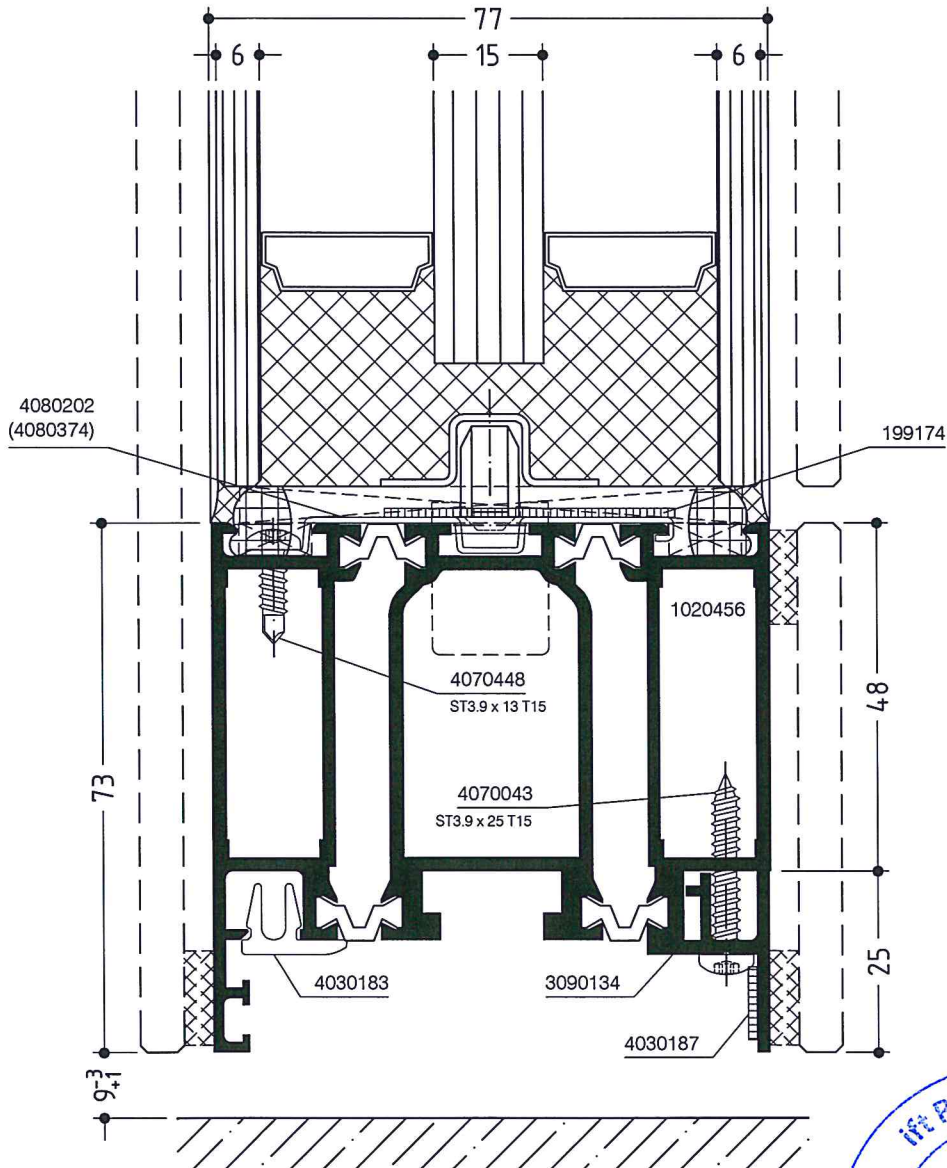
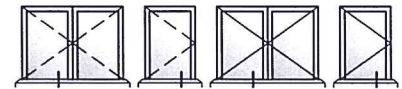

6. APR. 2017

WICSTYLE 77FP

Anschlagtüren Mittelstoß mit flächenbündiger Verglasung
 Hinged doors meeting stile with flush glazing

Konstruktionsschnitt
 Construction section

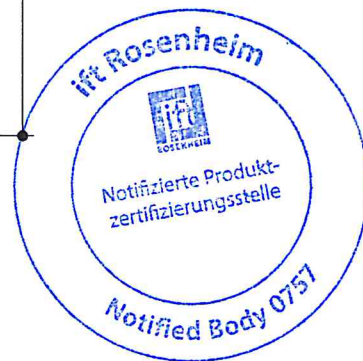
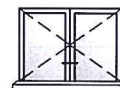
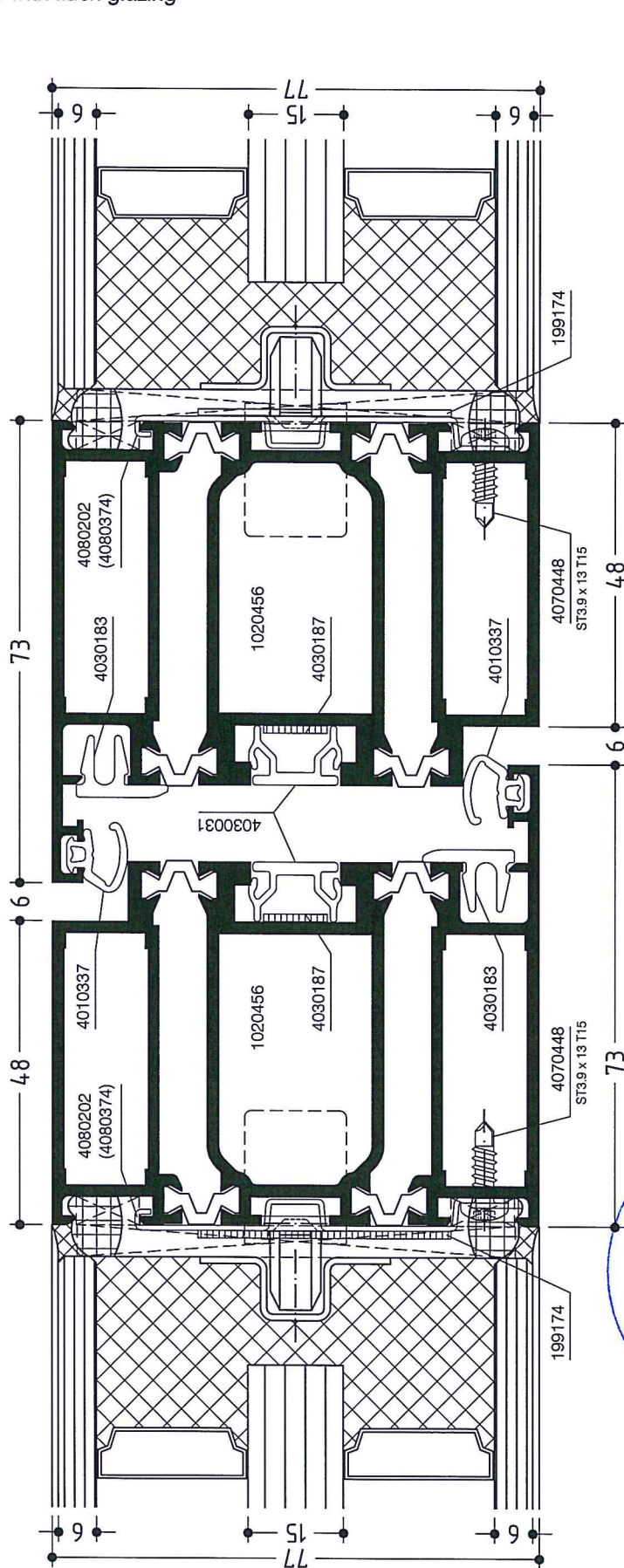

6. APR. 2017



WICSTYLE 77FP

Anschlagtüren einwärts mit Oberlicht-Festelement
 und flächenbündiger Verglasung
*Hinged doors inwards with fixed fanlight
 and flush glazing*

Konstruktionsschnitt
Construction section

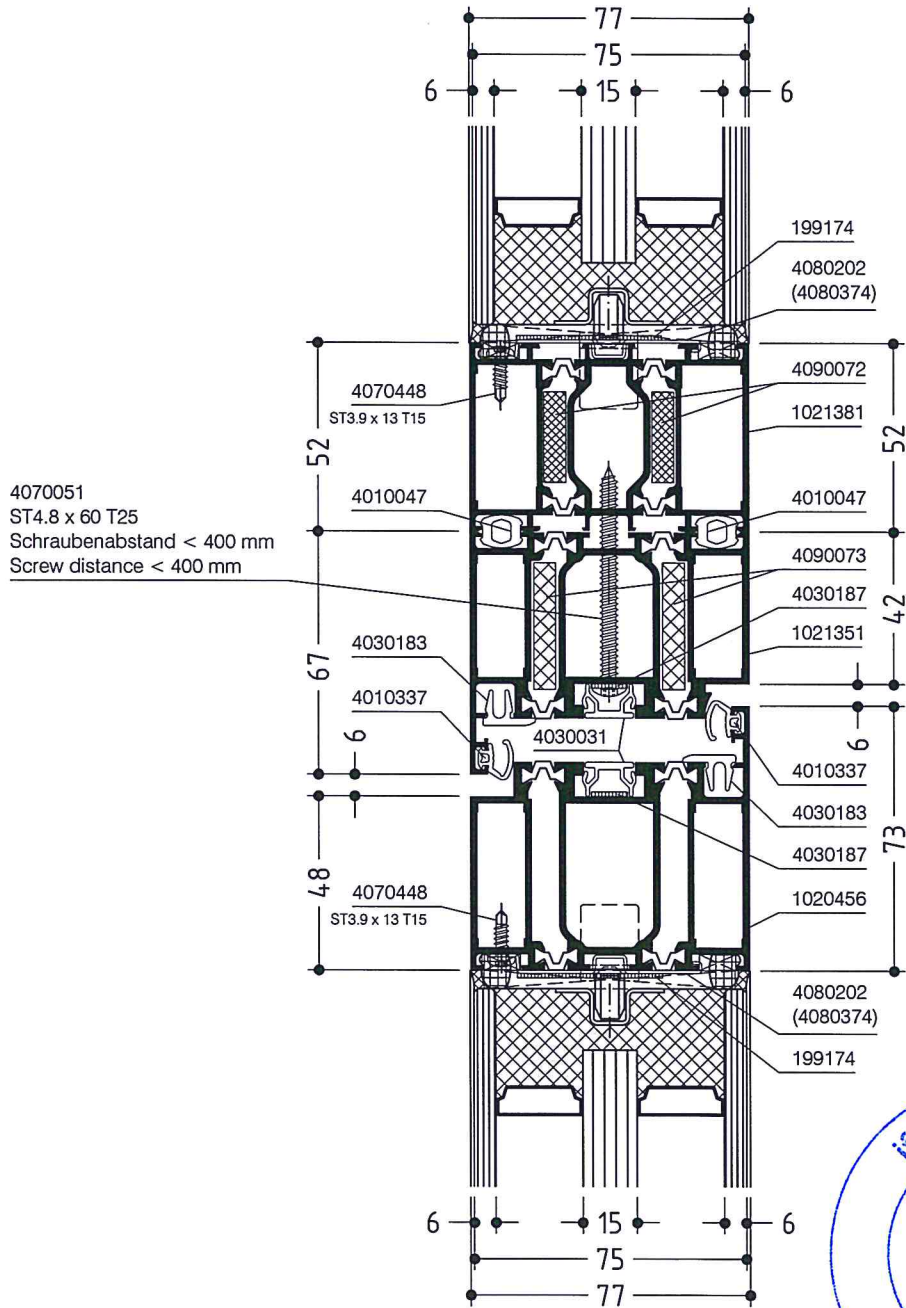
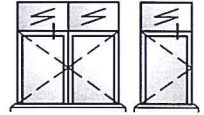

6. APR. 2017

WICSTYLE 77FP

Festfeld mit Sockelprofil und flächenbündiger Verglasung
Fixed field with bottom rail profile and flush glazing

Konstruktionsschnitt
Construction section

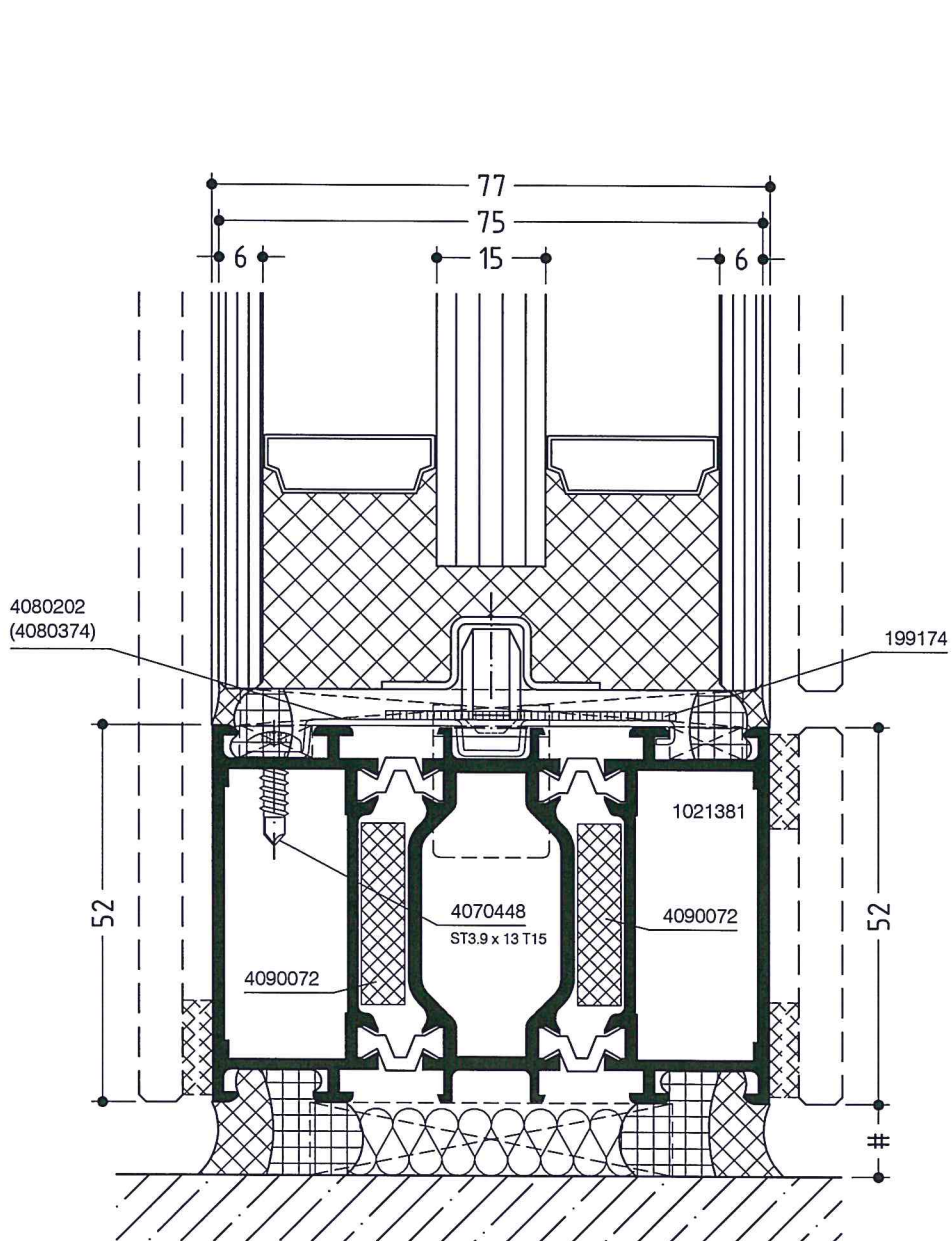
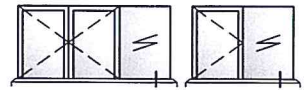

6. APR. 2017

WICSTYLE 77FP

Profilkoppelung mit flächenbündiger Verglasung
Profile coupling with flush glazing

Konstruktionsschnitt
Construction section

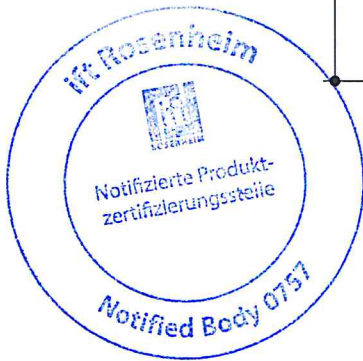
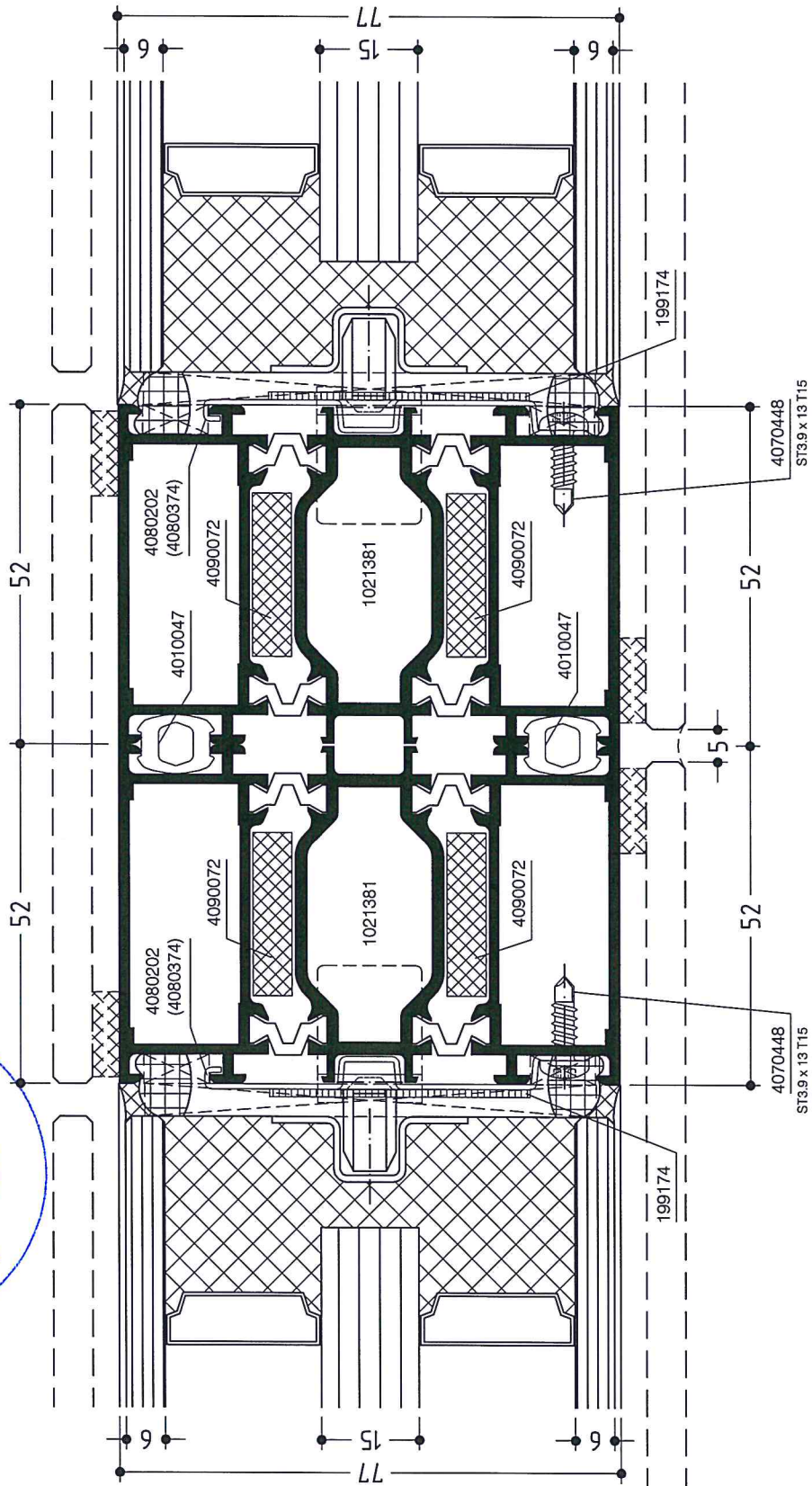
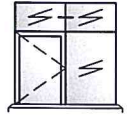

6. APR. 2017



WICSTYLE 77FP

Anschlagtüren auswärts mit EI30 in EI60 Verglasung
Hinged doors outwards with EI30 in EI60 glazing

Konstruktionsschnitt
Construction section

